

Westminster Exhibition Centre  
December 8 to 11, 1983



**Welcome  
to the  
BBC MICRO  
USER SHOW**

**Organised by  
Database Publications**

**FREE CONTEST**  
Entry Form on Page 23



# EXPLORE THE CRAZY WORLD OF BUGBLASTING

but watch out for Brian

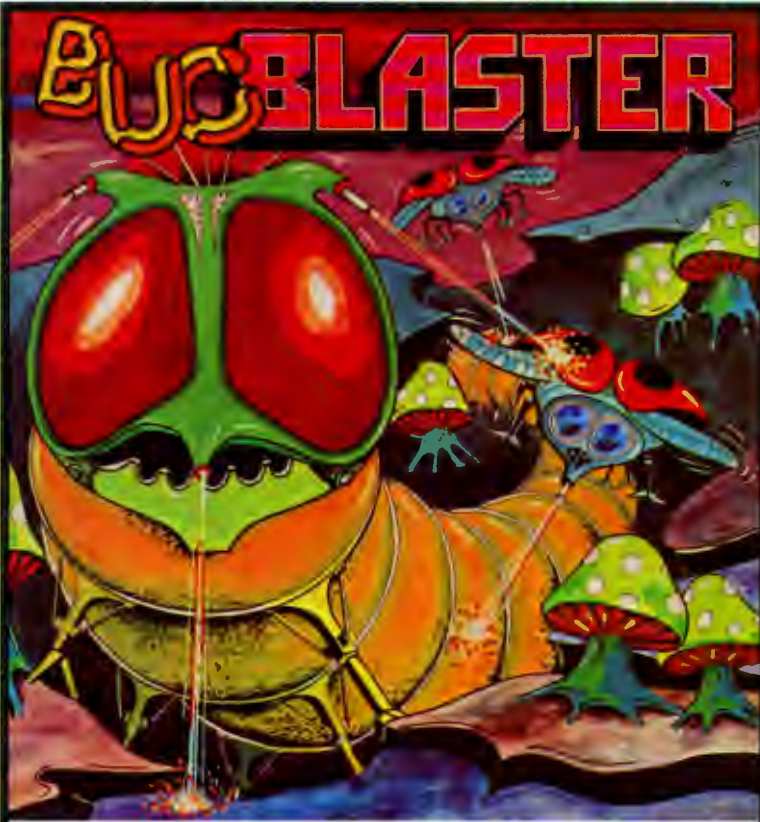

**Bugblaster** £7.95

A superb action packed arcade special. A really fast implementation of the splendid 'centipede.' Features include spiders, mushrooms, centipedes and the mushroom poisoning scorpion affectionately known as 'Brian.' The better you get the faster the action. Nerve tingling excitement should keep you up all night!

**Monaco** £7.95

Quality in under 60 seconds for the race of a lifetime - fantastic speeds, death-defying manoeuvres and a narrowing circuit - an exacting challenge for a future world champion.

**Lunar Rescue** £7.95

Land your moon buggy and rescue a precious cargo, destroying all opposition on the way; finding your way back to the mother ship start again against greater odds.

**Alligatacalc** £9.95

The master spreadsheet - business or home - accounts, costings, profit and loss - solve any financial or numeric problems with automatic formulae calculation.

**Fruit Machine** £5.95

Keeping your money in your pocket enjoy the excitement of beating the one arm bandit.

Order today by post or telephone!

Also available in this exciting range of games and utilities for the BBC Model B Micro:

Cosmic Asteroids .....	£5.95	DMON .....	£7.95 tape/£11.95 disk/£19.95 ROM
Scribe II .....	£9.95		
Primary Art .....	£9.95	Flexibase .....	£9.95 tape/£13.95 disk
ABM (Model A or B) .....	£5.95		

Superior Software Ltd. 178 Wood Street, Sheffield S1 4ET. Tel: (0742) 735005

Bugblaster  Monaco  Lunar Rescue  Fruit Machine  Alligatacalc

Card No: \_\_\_\_\_ for £ \_\_\_\_\_

Name \_\_\_\_\_ Address \_\_\_\_\_

Signature: \_\_\_\_\_

I enclose cheque/PO for £ \_\_\_\_\_

Order must be accompanied by payment. Payment should reach you within 7 days.

SOFTWARE WITH BITE



# The BBC Sideways RAM System

## The BBC Sideways RAM:

The most exciting add-on for the BBC micro, which many have been waiting for Acorn to produce!

Neater, more reliable and far more economical than plugging in more ROMs into your BBC!

## What is the Sideways RAM?

The sideways RAM is a 16K (upgradable to 128K) memory board which fits into the rightmost ROM socket on your BBC micro. The sideways RAM is an essential piece of hardware for any BBC computer. Strategically integrated into the BBC system, the system is capable of:

## Running Any Languages, Wordprocessor, Electronic Spreadsheet:

The sideways RAM allows you to run any software normally available in ROM such as WORDWISE, VIEW, BEEBCALC, BASIC2, FORTH, PASCAL, BCPL, EXMON, DISK DOCTOR, NET FILING SYSTEM, ENHANCED 16K DISK FILING SYSTEM, SPEECH ROM etc. . . . These programs can be saved on disk or tape and loaded later in seconds into the sideways RAM.

## Giving 27K Bytes Free with Acorn Disk Filing System:

The sideways RAM can also be used to increase available memory for BASIC, BEEBCALC, WORDWISE, VIEW etc. by moving disk workspace into sideways RAM. PAGE is then set to the lowest possible value, i.e. &OE00.

## Creating and Maintaining a Silicon Disk on your Computer:

If you have 128K of sideways RAM, 112K of it can be turned into a silicon disk. The system will address your floppy disk as drive 0 and the silicon disk as drive 1 but with a difference! The silicon drive has the capacity to load a 32K program faster than you can remove your finger from the 'RETURN' key with no clicking noise, no on/off LED, no wear. It can make you a backup floppy in 15 seconds from the original. The sheer speed of sideways RAM makes 3D-graphic look like a movie picture. It's life in the fast lane!

## Free Software with Every Sideways RAM System:

The Sideways RAM comes complete with lots of free software, now and with future updates. The free software includes "ROMCOPY" to move sideways ROMs to disc (or tape), STLOE00 to move disk filing system workspace into sideways RAM thus giving 3K bytes extra memory to BASIC, WORDWISE, VIEW, BEEBCALC, etc., STLDISC to create and maintain a SILICON DISK on your system with extra disk facilities and demonstration programs.

Future releases include our own DFS (JAN. 84) and SILICON 100K DISK BASIC (MARCH 84). All sideways RAM system software is given in basic source code. Users are encouraged to personalise and benevolent contributors will be rewarded with free hardware gifts.

## Increase the Computer Power by Increasing Sideways RAM:

The BBC comes with 32K of RAM and has access to a maximum of 3 languages. The BBC with 16K sideways RAM has 48K of RAM and has access to a wealth of languages. The BBC with 32K sideways RAM can run 2 loaded languages at the same time. The BBC with 128K sideways RAM can run 8 loaded languages at the same time. The power of the BBC relies on its intelligent use of software where several sideways ROMs execute different tasks such as filing, processing, debugging etc. The bigger the sideways RAM, the bigger the task the computer can handle.

The sideways RAM is such a powerful and promising device that ACORN HAS PLANNED to release a similar system on the ELECTRON.

Rather than being a software piracy aid, the Sideways RAM system is the key solution to selling more software to BBC computer users. This is because powerful sideways software can be shared by users of the same network and sold cheaper on tape, disk or by electronic mail.

## Beautifully Designed, Easily Installed, no Soldering Required:

The sideways RAM was first introduced and the first issue sold out at the ACORN USER SHOW (Sept. 83, London). The new issue has been exhibited at the PCW SHOW (Oct/Nov. 83, London) and will be on general distribution release at the BBC USER SHOW (Dec. 83, Westminster, London). The system can be installed in 2 minutes by yourself or most BBC dealers and requires no soldering.

## HERE IS HOW:

Open the computer case, plug into the rightmost sideways ROM socket the cartridge base unit (see picture 1). Install your sideways ROMs, one at a time, onto the mini ROM cartridge (see figure 2), insert the cartridge into the base unit and CHAIN "ROMCOPY". This program will save your sideways ROM on disk or tape. Locate S20 and S22 jumper blocks on the computer board. Replace the jumpers with control wires from the base unit. Install the sideways RAM card in place of the mini ROM cartridge. Switch on the computer and \*LOAD any program saved with "ROMCOPY". Press the BREAK key. Call up your sideways software as usual. For example, \*WORD etc.

Further upgrading to 32K or to 128K is very simple: from 16K to 32K is by straight exchange (cost: £12+p&p), from 32K to 128K is by plugging in the SOLIDISK extension (see figure 3) onto the 32K sideways RAM. It costs just £76 plus p&p.

## OTHER PERIPHERALS FOR THE BBC MICRO:

We are stockists of the EPSON range of PRINTERS, the SANYO range of COLOUR MONITORS, disk drives from various manufacturers and floppy diskettes (WABBASH, VERBATIM, DATALIFE, DYLAN etc.). Ring us for a quotation.

MADE IN ENGLAND  
BY SOLIDISK TECHNOLOGY LIMITED  
17 SWEYNE AVENUE SOUTHEND-ON-SEA  
Essex SS2 6JQ  
TEL: SOUTHEND (0702) 354674

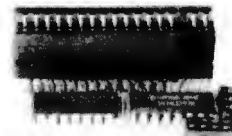

THE CARTRIDGE BASE

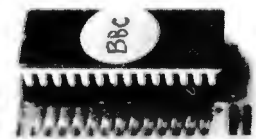

THE ROM CARTRIDGE

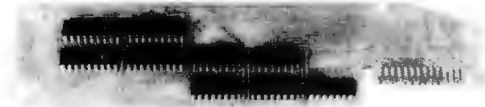

THE SIDE WAY RAM CARD



THE SILICON DISK EXTENSION

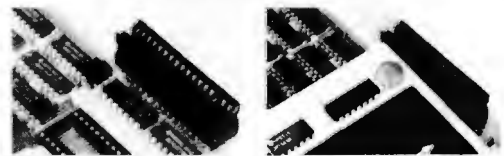

INSTALLING THE CARTRIDGE BASE



USING THE ROM CARTRIDGE TO TRANSFER SOFTWARE ON DISK

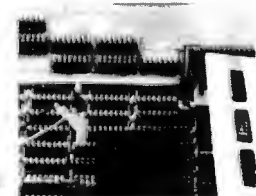

THE SIDE WAY RAM NOW REPLACES THE ROMS

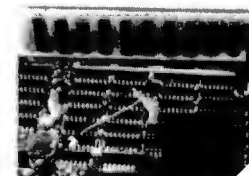

THE SOLIDISK SUPER FAST DRIVE IS NOW INSTALLED

## THE BBC-SIDE WAY RAM SYSTEM

Item	Qty	Price inc VAT	Total
BBC 16K SIDE WAY RAM		£34.95	
BBC-32K SIDE WAY RAM		£46.95	
BBC-SOLIDISK		£119.95	
SOLIDISK extension alone for BBC-32K Side Way Ram, if bought separately:			£76.00
Post and packing			£1.00
TOTAL £			£ 1.00

Please charge my Access, Barclay account: \_\_\_\_\_

NAME \_\_\_\_\_

ADDRESS \_\_\_\_\_

TOTAL £ \_\_\_\_\_

for: £ \_\_\_\_\_

\* Please delete/complete as applicable  
\* enclose a cheque/ P.O. payable to: SOLIDISK TECHNOLOGY LTD

# Electronequip in Hampshire

**SPECIAL OFFERS**  
PHONE FOR DETAILS



Electronequip is an authorised Acorn service centre and has been an Acorn dealer since the introduction of the Acorn. Our demonstration facilities include 20 station Econet and Torchnet systems.

Ref.	BBC Micros	Ex VAT	Inc VAT
ANB01	BBC Model B Micro Computer	348.26	399.00
ANB02	BBC Model B with Econet Interface	389.14	446.00
ANB03	BBC Model B with Disc Interface	409.14	469.00
ANB04	BBC Model B with Disc & Econet Interface	450.01	516.00

**3" Micro Disc £129.95**  
(inc. VAT)

**Disc Interface & Drive**  
**£198.95** (inc. VAT)

**Micro Disc Drive for the BBC Micro**

The Micro disc drive offers a method of low cost quick access to programs. The drive is essentially a small version of a 5¼" disc drive and offers similar features to the larger drive. The data is stored on a 3" disc, this is enclosed in a protective hard plastic cassette which features a write protect switch. The micro drive requires the standard Acorn disc interface, but a new disc filing system rom. Acorn DFS may be exchanged for the micro DFS for £12.00. The new micro disc filing system allows 60 files per disc surface and it can read and write to Acorn DFS discs. Thus if a 5¼ inch and a micro floppy were connected on the same cable files could be transferred between them.  
**Capacity: 80.64 K bytes Transfer Rate: 125kbit/s**

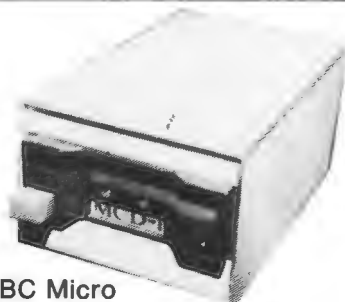

**TRADE ENQUIRIES WELCOME**  
Access & Barclaycard Accepted  
Large Stocks - 24 Hour Despatch  
Carriage 50p to £3.50

## NORDMENDE

14" TV/Monitor £217.00 + VAT

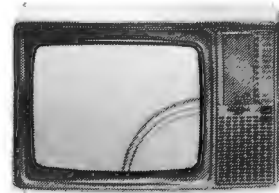

Ref.	Monitors	Ex VAT	Inc VAT
MNB1401	BMC 1401 Colour Monitor	225.00	258.75
MNCE370A	Cable CE 370A Colour RGB Monitor	199.00	228.85
MNKVIS2	Kaga 12" RGB Monitor Vision II (Medium)	285.00	327.75
MNKVIS3	Kaga 12" RGB Monitor Vision III (Hi)	399.00	458.85
MNN1431	Microvitec 1431 14" Colour Monitor (BBC)	215.00	247.25
MNN1441	Microvitec 1441 High Res 14" BBC Monitor	440.00	506.00
MNN1451	Microvitec 1451 Medium Res 14" BBC Monitor	325.00	373.75
MNN1534	Nordmende 14" TV/Monitor	217.00	249.55
MNN3534	Nordmende 14" TV/Monitor with remote control	234.00	269.10
MNN4430	Nordmende 20" Prestige TV/Monitor remote	417.00	479.55
MNN4432	Nordmende 22" Prestige TV/Monitor remote	458.00	526.70
MNN4437	Nordmende 27" Prestige TV/Monitor remote	512.00	588.80

**SIDEWISE**

**SIDEWISE FITTED**

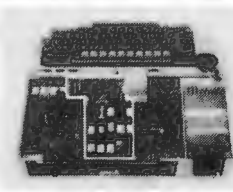
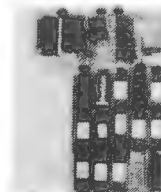

"SIDEWAYS" rom board for BBC Micro.  
No soldering required £38.00 + VAT

## EPSON

**RX-80** £263.12 + VAT

**FX-80** £365.09 + VAT

Printer price includes cable for BBC and screen dump rom.

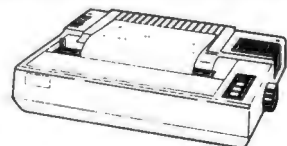

## TORCH COMPUTERS

Perfectly Made in Britain

Ref.	Torch Computers	Ex VAT	Inc VAT
TC301	Torch Work Station (No monitor) (301)	1244.00	1430.60
TC303	Torch Work Station with TOSCA (No monitor)	1449.00	1666.35
TC401	Torch Computer twin 400K (new style)	2250.00	2587.50
TC403	Torch Computer twin 400K & TOSCA (grey)	2455.00	2823.25
TC68000	Torch Computer twin 400K Floppy & 68000	3550.00	4082.50
TC68020	Torch Computer 20Mb Hard Disc & 68000	5900.00	6785.00
TCF500	Torch Computer twin floppies (CF500)	2950.00	3392.50
TCFS500	Torch Computer twin 400K & TOSCA (CH500)	3150.00	3622.50
TCH520	Torch Computer 20Mb Winchester CH520	5650.00	6497.50
TCHS520	Torch Computer 20Mb Hard Disc & TOSCA	5850.00	6727.50
TMC240	Torch Computer Monitor (MC240)	575.00	661.25



# Electronequip



36-38 West Street, Fareham, Hants (0329) 230670

**Electronequip**  
in  
**Hampshire**

**THE BEST THING  
TO HAPPEN TO  
THE BBC MICRO**



**MICRO DISC DRIVE**

**£129.95 (inc. VAT)**

(Available ex-stock now)



**Electronequip**



36-38 West Street, Fareham, Hants (0329) 230670

# Software for the BBC micro

## **Graphics** **ROM**

The graphics extension ROM for the BBC micro

Our latest utility ROM includes over 28 new graphics related commands. These can be typed in like any normal commands and can, of course, be included in BASIC programs.

**also**

other ROMS for the BBC Micro 32K being demonstrated at this show are:

**WORDWISE**

**DISC DOCTOR**

**GREMLIN**

**TERMI**

**All ROMS  
Demonstrated  
on stands  
127 & 128**

**COMPUTER  
CONCEPTS**

16 Wayside, Chipperfield, Herts WD4 9JJ. Telephone (09277) 69727



**HERMANN  
HAUSER,  
Joint Managing  
Director of  
Acorn Computers,  
looks ahead to  
what 1984 will  
offer BBC Micro  
users.**

DURING 1983 Acorn introduced two major new pieces of hardware – the Electron, which has been greeted with great acclaim by all who have seen and used it, and the Teletext Adaptor for the BBC Micro that turns any TV or monitor into a teletext receiver and allows the user to download BBC telesoftware – the world's first broadcast software service.

1984 will see many more new product launches from Acorn. The first quarter alone will have the launches of 6502 and Z80 second processors, the Bitstik mini-CAD system and a Prestel Adaptor.

All of these products are previewed here at the BBC Micro User Show.

Later in the year Acorn will be making its first entry into the crowded business market with products that are likely to be as world-beating as the BBC Micro is in the home/education market.

Software too is exploding with more choice than ever for the Acorn user. New programs are appearing at a bewildering rate, with education and programs for the small business to the fore.

The BBC Micro is finding an ever-increasing circle of friends. Scientific and industrial establishments of all kinds that use control and test equipment can now use the BBC Micro with an IEEE interface to control and monitor the functions of that equipment.

This is just one example of how Acorn is helping industry to function more efficiently and at a lower cost and yet the same machine is teaching children in schools all over the country and playing spectacular games in thousands of homes.

The BBC Micro and the Acorn Electron are both products that are designed to expand with the user and provide many years of use and pleasure into the foreseeable future.

# ONE-STOP SHOPPING

**KEENEST PRICES,  
PROMPT, RELIABLE  
SERVICE ---  
that's TWILLSTAR!**

## BBC MICROCOMPUTER

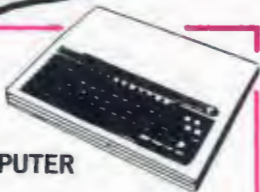

Model B.....	£399
Model B & Disc Interface.....	£469
Model B & Econet.....	£446
Model B & Econet & Disc Int.....	£516
Disc Interface Kit.....	£97
* Speech Synthesizer (official BBC).....	£54
Teletext Receiver.....	£225
1.2 Operating System (incl. fitting).....	£11.50
Basic 11.....	£15

\* New in stock. Price incl. fitting.



**NOW AVAILABLE  
THE ACORN ELECTRON  
ONLY £199.00**

## WORD PROCESSORS

View Word Processor.....	£59
Word Wise Word Processor.....	£45

## Logitech-FT 5001

**STAR  
BUY**

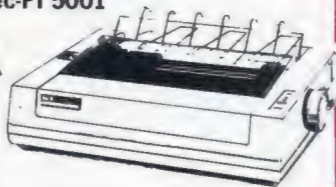

Friction and adjustable sprocket feeding, variety of printing models, (PICA & ELITE pitch) user font registry command, automatic paper insertion, 96 ASCC11 with descender, 8 international character sets, 48 semi graphics!

**At the very low price of £330**

**Just look at our prices and selections: but if you don't see what you want please telephone us, as we are unable to list all the items we stock. We will be more than pleased to give you our Best price, and our very best wishes for Christmas!**

## DOT MATRIX PRINTERS

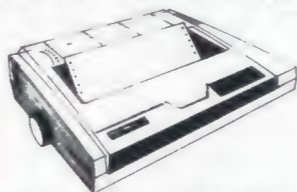

### MANNEMANN MT80

High quality 80 column serial dot matrix printer. Dual density dot addressable graphics, quick tear facility as standard, optional sound reduction kit to give an impressive L55dBa acoustic noise rating. Ability to handle both tractor-fed fanfold and single paper.

**Special price of £295**

**FREE CABLE AND  
PAPER WITH ALL  
PRINTERS.**

### EPSON F80

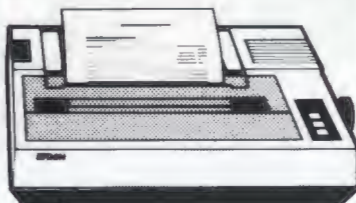

Epson FX80 F/T.....	£425
Epson RX80 F/T.....	£315
Epson FX100 T/T.....	£499

### SHINWA CP80

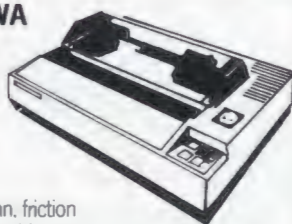

80 column, friction and adjustable tractor feed, bidirectional logic seeking, HI-RES graphics and block graphics, sub and superscripts, condensed and emphasised print, and underlining, vertical and horizontal tabs, self test, italic print, etc.

Shinwa CP80 F/T.....	£289
Parallel Printer Lead.....	£13
2000 Sheets Fanfold Paper.....	£15

### ODDS

Official Joysticks.....	£13
Compatible Joysticks Damping Control.....	£15
Dust Covers - for various machines - from.....	£3.95

## DAISYWHEELS



### JUKI 6100

20 CPS print speed, supports all wordstar features, emulates diablo protocols.

Juki 6100 Daisywheel with 2K Buffer..... **£395**



### BROTHER HR15

Buffer... 3K byte, shadow printing, super/sub script, carriage skip movement, text reprinting, colour printing (red and black), auto under-scoring, proportional spacing, clear buffer—

**Also available with keyboard.**

Brother HR15.....	£431
Keyboard.....	£176

**\* STAR  
BARGAIN!**



**BBC Model B plus Disc/Interface fitted view, V.D.U. Green Monitor, Juki Daisywheel Printer, 200K Dual Disc Drives and manual and formatting disc. ONLY £1,360 (incl. all cables)**

**ALL PRICES INCLUSIVE OF VAT.**

**SEE US  
ON STAND(S)  
97,98,107,108**

**TCL**

**Twillstar Computers Limited**

Microcomputers, Peripherals, Software, Service Contracts.

**NEWS  
FLASH!  
ACORN-APPROVED  
AND APPROVED  
ECONET SERVICE  
CENTRE  
\*\*\*\*\***



# to fill your Christmas **MICRO** stocking!

## MONITORS

You can use this latest Philips Green Monitor for, personal computers, business computers, control systems, automatic test equipment. The picture quality of the TP200 means not only 80 x 24 lines of information but also usage for high resolution graphics.

### PHILIPS TP200 Green Monitor



At the bargain price of **£79**  
BBC Official 12" ..... **£95**

### NORDMENDE 14" TV/MONITOR



This TV/Monitor is not a modified television as many TV/Monitors are, but a 14" TV/Monitor which has been designed to perform both functions. It has RGB and Composite video and sound. An RGB cable for a BBC is supplied as standard.

With Remote Control: ..... **£269**

**Colour monitor**  
Microvitec 14" 1431 ..... **£247**

## TORCH DISK PACK

**Torch Z80 Disk Pack**  
4MHZ Z80 Application Processor  
Perfect Software

At New Low Price  
**£835.00 Inc. Installation**

## SLIM DISK DRIVES

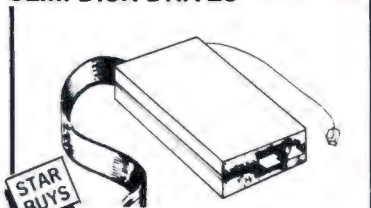

<b>TEAC 55A S/S 40 TRACK</b>	
100K SD Single	£169
200K DD Dual	£339
<b>TEAC 55E S/S 80 TRACK</b>	
200K Single	£220
400K Dual	£440
<b>TEAC 55F D/S 80 TRACK</b>	
400K S/D Single	£269
800K D/D Dual	£539
<b>MITSUBISHI</b>	
400K D/S DD Single	£269
Dual	£539
<b>FORMATTING DISK &amp; MANUAL</b>	<b>£10</b>
*ALL DRIVES CASED WITH FREE CABLES	

- \* SERVICE CONTRACTS TO EDUCATION AUTHORITIES AT DISCOUNT
- \* OFFICIAL ORDERS FROM DEALERS, GOVERNMENT DEPARTMENTS, COLLEGES AND SCHOOLS WELCOME
- \* ALL PRICES INCLUSIVE OF VAT



### KOMORI - MICROPROCESSOR CONTROLLED

Ideal for BBC Micro and any other computers with standard interface 5 1/4" Slimline. on-board single chip microcomputer reduces TTL count by 70%, extra low power requirement direct drive (no belts), guide rail means completely quiet operation unique eject mechanism, fast 6ms track to track access time fully guaranteed Cased with leads  
Priced at the **STAR BARGAIN PRICE** of **£169**

Power supply **£40**  
Cables Single **£9.50**  
Cables **£13.50**

## FLOPPY DISKS



Floppy Disks in packs of 10  
Single sided 40 Track **£20**  
Double sided 80 Track **£35**

## BBC Compatible

### KLIK STIK JOYSTICK SELF CENTRING



Two Fire Buttons

Single - **£17.95**

Dual - **£34**



## SANYO

### SLIM 3G



The slim 3G Sanyo Cassette Recorder only recently available in the market - ONLY **£28.95**  
Official BBC Cassette Recorder **£29.95**  
Cassette Recorder lead **£2.50**

## UTILITY SOFTWARE

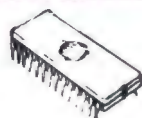

Screen Dump Rom **£17.25**

Analyse Disk **£15**

Compatible for MX80, FX80 etc.

## NEW BOOKS AND SOFTWARE IN STOCK

\*\*\*\*\*

FITTING SERVICES AVAILABLE

## SOFTWARE ACORN SOFT GAMES

Creative Graphics **£9.95**  
Graphs & Charts **£9.95**  
Desk Diary **£9.95**  
Monsters **£9.95**  
Snappers **£9.95**  
Planetoid **£9.95**  
Arcade Action **£11.50**  
Rocket Raid **£9.95**  
Meteors **£9.95**  
Arcadians **£9.95**  
Sliding Block **£9.95**  
Cube Master **£9.95**  
Chess pack **£9.95**  
Super Invaders **£9.95**  
Missile Base **£9.95**  
Snooker **£9.95**  
Starship Command **£9.95**  
Draughts/Revers **£9.95**

## ADVENTURES

Sphinx Adventure **£9.95**  
Philosophers Quest **£9.95**  
Castle of Riddles **£9.95**  
Countdown to Doom **£9.95**

## LANGUAGES

Lisp **£16.85**  
Forth **£16.85**  
Microtext **£49.85**  
BCPL **£99.00**

## EDUCATION

Algebraic Manipulation **£9.95**  
Peeko Pack **£9.95**  
Business Games **£9.95**  
Tree of Knowledge **£9.95**  
Sentence Sequencing **£11.90**  
Word Sequencing **£11.90**  
Missing Signs **£11.90**  
Number Balance **£11.90**  
Word Hunt **£11.90**  
Speed & Light **£11.90**  
Density & Circuit **£11.90**  
Chemical Analysis **£13.80**  
Chemical Simulations **£13.80**  
Chemical Structures **£13.80**  
Jars **£11.90**

## BOOKS

Creative Graphics **£7.50**  
Graphs & Charts **£7.50**  
Lisp **£7.50**  
Forth **£7.50**  
View Guide **£2.50**  
Intro View **£2.50**  
BCI Manual **£15.00**

## BBC GAMES SOFTWARE (BUG BYTE)

Galaxy Wars **£7.50**  
Oblivion **£7.50**  
Red Lord **£7.50**  
Music Synthesizer **£9.50**  
Graphics Package **£9.50**  
Old Farmer Time **£9.50**  
City Defence **£9.50**



## (COMPUTER CONCEPT)

Asteroid Belt **£8.99**  
Characters **£6.65**  
Hitch-Hiker **£6.85**  
Snake **£8.95**  
Space Hawks **£8.95**

## PROGRAM POWER

Felix in the Factory **£7.95**  
Felix and the Fruit Monsters **£7.95**  
Escape from Moonbase Alpha **£7.95**  
Danger UXB **£7.95**  
Moon Raider **£7.95**  
Bandits at 3 O'clock **£6.95**  
Swoop **£7.95**  
Croaker **£7.95**  
Alien Swirl **£6.95**  
Chess **£7.95**  
Asteroid Storm **£7.95**  
Command **£7.95**  
Wall **£5.95**  
Beebtole **£5.95**  
Caveman Adventure **£6.95**  
Revers **£5.95**  
Physics **£6.95**  
Chemistry **£6.95**  
World Geography **£6.95**

## BUSINESS SOFTWARE

**Word Processors Room Based**  
Word Wise **£44.85**  
View **£59.30**

## GEMINI

Cash Book Accounts **£59.95**  
Final Accounts Program **£59.95**  
Invoices and Statements **£19.95**  
Commercial Accounts **£19.95**  
Mailing List **£19.95**  
Data Base **£19.95**  
Stock Control **£19.95**  
Home Accounts **£19.95**

## Spread Sheet Analysis

Beebcalc Rom **£39.00**  
(Also available on 40/80 Disc)

## BOOKS

30+ Programs - BBC Micro **£4.95**  
30 Hour BASIC (BBC Micro) **£6.00**  
6502 Application Book **£10.25**  
Advanced 6502 Interlacing **£10.95**  
BBC Micro Revealed **£7.95**  
BBC Micro Instant Machine Code Including Software Cassette **£34.00**  
Creative Graphics on BBC Micro **£7.50**  
Discover FORTH Osborne **£11.25**  
Easy Prog for BBC Micro **£6.50**  
Further Prog for BBC Micro **£5.95**  
FORTH Programming (Sams) **£12.50**  
Advance BBC Micro user Guide **£12.95**

Basic Programming for BBC Micro **£9.95**  
21 Games for BBC Micro **£5.95**  
Intro to Micro Beginners Book (3 Ed) **£9.90**  
Let Your BBC Teach You to Program **£6.75**  
Micros in the Classroom **£4.90**  
Practical Prog for BBC & ATOM **£5.95**  
Programming the 6502 **£10.75**  
Structured Prog with BBC BASIC **£9.50**  
The BBC Micro an Experts Guide **£7.90**  
6502 Games **£9.75**  
Basic Handbook (2nd Ed) **£15.75**  
Advanced BASIC **£9.95**  
BASIC Computer Prog for the Home **£9.70**  
ALP for BBC Computers **£8.95**  
BCPL for the BBC Micro User Guide **£15.00**  
Games BBC Computer Play **£6.95**  
Basic Programming on the BBC Micro **£5.95**  
30 Hours Basic **£5.95**  
35 Educational Programmes for BBC Micro **£6.95**

## HOW TO ORDER

You may purchase any of the items listed by cheque, Barclaycard or Access. All you have to do is fill in the details in the coupon below and list your requirements on a separate sheet of paper. Post to us and we will despatch within 7 to 14 days. All prices inclusive of 15% VAT.

Add £2.50 P&P for orders below £150, over, add £8 P&P.

\*\*\*\*\*

## TELEPHONE ORDERS (01) 574 5271

Credit card holders may order by telephone. Give Card No., Name, Address and item required.

Post to:  
**TWILLSTAR COMPUTERS LTD,**  
17 REGINA ROAD, SOUTHALL, MIDDLESEX.

I have enclosed my list of requirements along with my cheque/P.O. for £ \_\_\_\_\_

I prefer to pay with my ACCESS/BARCLAYCARD (Delete whichever not applicable)

CARD NO. \_\_\_\_\_

SIGNATURE \_\_\_\_\_

NAME \_\_\_\_\_

ADDRESS \_\_\_\_\_



TEL: (Day) \_\_\_\_\_  
TEL: (Eve) \_\_\_\_\_



BBCM-1

**17 REGINA ROAD · SOUTHALL**  
**MIDDLESEX · TEL: (01) 574 5271**  
**(OPEN SIX DAYS A WEEK - 10 a.m. to 8 p.m.)**

CREDIT CARDS VALID IF SIGNED BY CARD HOLDER. ADDRESS ABOVE MUST BE THE SAME AS CARD HOLDER.

# ***Expanding opportunities to learn in 1984/85***

**By JOHN RADCLIFFE,  
Executive Producer,  
Continuing Education,  
BBC Television**

THE development of the Computer Literacy Project so far seems to have done much to stimulate interest in learning opportunities in the field of information technology, and has also enabled the BBC to develop considerable expertise and many contacts in the field.

The Referral Service, the BBC Microcomputer, the BBC Software List, and the network of contacts and links which the project has established, all provide a solid support for future broadcast series.

Two of the new Continuing Education television series in preparation for 1984 will provide further learning opportunities in the field of data processing ("Electronic Office") and control ("Computers in Control").

Both of these series should be of value both to home users, and to schools, colleges, and industrial training departments.

The third programme, "Micro Club", will be aimed at the growing band of computer hobbyists, and should have particular appeal to younger computer users.

Looking further ahead to 1984/5, there are preliminary plans for major series on the computer as a "learning machine", and on the social implications in the mid 80s of the computer revolution.

There are various other plans for radio and television series in this broad field by the BBC Schools Broadcasting Departments and the Open University.



## **Telesoftware adds that extra dimension**



**By LAWSON BROWN, Head of Telesoftware, BBC**

THE BBC Telesoftware service is the first regular broadcast service of computer programs in the world. It is an extension of the BBC Teletext service, CEEFAX, and aims to provide an increasingly wide range of free software and data to anyone who has a BBC Model B Micro and a teletext adapter.

At present, the service has an educational bias but it also provides a variety of programs, including software 'tools', the occasional game, software reviews and other applications software.

The teletext adapter, which has been designed as an integral part of the BBC Micro computer system, opens up access to an exciting range of applications.

It transforms an ordinary TV set or monitor into one capable of receiving teletext and gives the user access to advanced features of the service (such as linked

pages) not available to those with ordinary teletext sets.

Pages may be "archived" – that is, stored, on disc or cassette – and more importantly, interrogated by telesoftware so that the constantly updated CEEFAX data may be processed by ordinary applications programs. The BBC are also investigating the possibility of providing volatile data via telesoftware.

Telesoftware will add an extra dimension to traditional broadcasting. It is being commissioned to accompany TV and radio programs (initially in the field of education) and will become increasingly available during 1984.

It is a technological innovation with almost limitless possibilities which will gradually be realised as the service grows and develops.

**YOU CAN  
ALSO DO IT  
IN 5 SECONDS!**  
COME AND SEE US  
AT STAND No 28, 29, 30!

Replacing your Cassette with a Disk Drive, means DATA ACCESS in less than 5 seconds!

If you are looking for a guaranteed Disk Drive, fully BBC compatible, at a price that includes VAT, formatting disk, user manual, cases and leads, then just look at our all-inclusive prices!

**TEAC SLIMLINE DRIVES  
Including VAT**

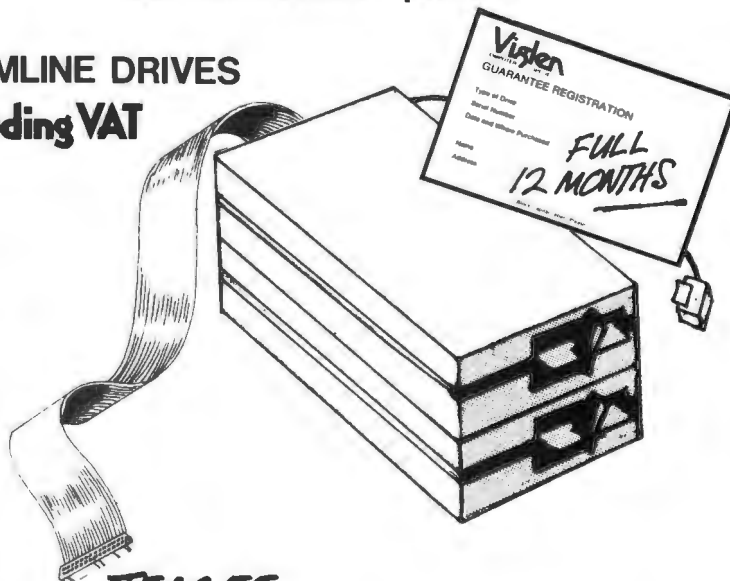
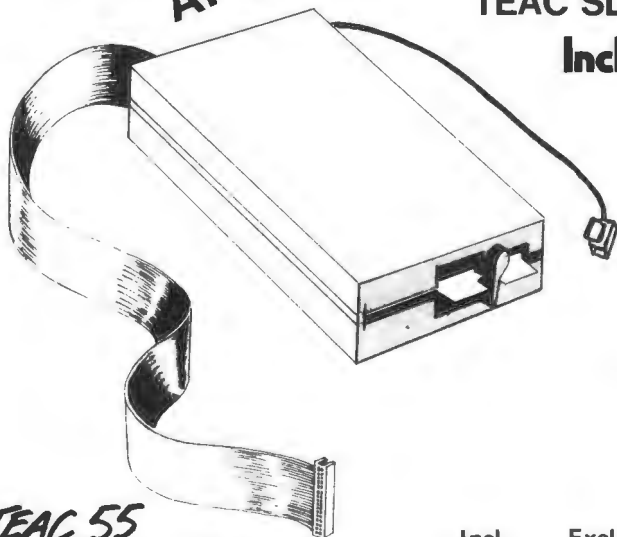

**TEAC 55**

**SINGLE DRIVES CASED**

	Incl. VAT	Excl. VAT
40 TRACK 100K	£166	£144.35
40 TRACK 200K	£230	£200.00
40/80 TRACK SWITCHABLE 200K	£199	£173.05
40/80 TRACK SWITCHABLE 400K	£257	£223.48

**TEAC 55**

**DUAL DRIVES CASED**

	Incl. VAT	Excl. VAT
40 TRACK 200K	£320	£278.26
40/80 TRACK SWITCHABLE 400K	£402	£349.57
40/80 TRACK SWITCHABLE 800K	£520	£452.18
DFS KIT	£75	£65.22
P.S.U.	£32.20	£28

MITSUBISHI DRIVES	Excl. VAT	Incl. VAT
400K SINGLE DRIVE	£213.04	£245
800K DUAL	£379	£435.85
800K & POWER SUPPLY	£399	£458.85

\*These drives are fully compatible with other Computers and can be used should you change your computer.

\*Check our special terms for Educational Establishments and Government Departments

**DEALER ENQUIRIES WELCOME**

**HOW TO ORDER**

**BY POST**

To purchase any of the items simply fill in your requirements listed above, in the coupon. Enclose your cheque/P.O. or use your Access or Barclaycard. Please make cheque payable to; VIGLEN COMPUTER SUPPLIES and post to address below, allow 7 to 14 days for delivery & add £ 8-00 postage, package & insurance on all prices.

**BY TELEPHONE**  
-(01) 843 9903

Credit Card holders (Access/Barclay Card only) can purchase by telephone. Please give Card No, Name, Address and the item required.

**ENQUIRE ABOUT OUR 24-HOUR  
GUARANTEED  
DELIVERY SERVICE!**

Post to; VIGLEN COMPUTER SUPPLIES UNIT 7  
TRUMPERS WAY · HANWELL · W7 2QA

Please send me the following items :

\_\_\_\_\_

\_\_\_\_\_

I enclose Cheque/P.O. for £ \_\_\_\_\_

I prefer to pay Access/Barclaycard  
(Delete whichever not applicable)

CARD No \_\_\_\_\_

SIGNATURE \_\_\_\_\_

NAME \_\_\_\_\_

ADDRESS \_\_\_\_\_

\_\_\_\_\_

Tel (Day) \_\_\_\_\_ Tel (Eve) \_\_\_\_\_



CREDIT CARDS VALID IF SIGNED BY CARD HOLDER.  
ADDRESS ABOVE MUST BE THE SAME AS CARD HOLDER.



**Viglen**  
COMPUTER SUPPLIES

UNIT 7 TRUMPERS WAY  
HANWELL W7 2QA  
Tel: (01) 843 9903



# WHO'S WHERE AT THE SHOW

Stand No.	Company Name		
1	Acorn Computers Ltd	93	Lowland Designs
91	Advanced Memory Systems	78	M.E.P.
59	Akhter Instruments	58	M.G.B. Software
120	Alligata Software	15	MYB Software
81	BBC Telesoftware	70	Master Class Video Cassettes
8	British Micro	18	Microvitec
57	Bucon Ltd	38	Microware
44	CJE Microcomputers	16	Micro Aid
83	C-Tech Computers	64	Micro Power
101	CWP Computers	106	Micro Resources
86	Cambridge Computer Consultants	90	Micro User
123	Clares Micro Supplies	13	Micro User Groups (MUG's)
122	Clwyd Technics	137	Micro User Technical Advice
136	Commotion	72	Miniature Tool Company
5	Computer Agencies	45	National Micro Centres
125	Computer Concepts	12	OIC Ltd.
46	Concerned Technology	76	Oak Software
133	Cumana	82	Oakleaf Computers
84	Datel	105	Optima Software
34	Display Distribution	71	Opus Supplies Ltd.
117	Economatics	14	Oxford Microware
95	Educational Computing	109	Pace Software
132	Educational Software	17	Press Stand
77	Electronequip	6	R.H. Electronic Sales
39	Electron User	51	Senator Software
7	Electronic Classroom	4	Softspot
112	GSL	49	Software Invasion
2	Glengary	121	Solidisk
3	Golem	21	Superior Software
129	Integrex Ltd.	116	SYSTEM
139	Kansas City Systems	97	Twillstar Computers
96	Kirklands Computer Centre	28	Viglen Computers
7	L.C.L.	67	Watford Electronics
138	Logic Sales	75	Watford Technical Books

## Stand 1

**Acorn Computers Ltd., Fulbourn Road, Cherry Hinton, Cambridge, CB1 4JN. Tel: 0223 245200.**

Acorn are offering a total "Hands-On" stand featuring all of their major products. Star of the stand will be the recently launched Electron home micro, a 32K Ram machine that offers many of the most powerful features of the Acorn BBC Micro Model "B", but at £199 including VAT, for half the price. Visitors will be able to use the Electron and try out Acornsoft's new Electron Software, including six new games.

The remainder of the stand will be devoted to the Acorn BBC Micro and Associated products and Acornsoft Software. The new telesoftware adaptor will be on show demonstrating how the teletext broadcast software can be captured by the adaptor for running on the BBC Micro. Other add-ons on show will include the Z80 and 6502 second processors and Prestel Adaptor, and many of the BBC Micros will be linked together through Econet, Acorn's local area network.

## Stand 2

**Glengary Soft, 9 Highfield Crescent, Hornchurch, Essex. RM12 6QB. Tel: 04024 40864.**

All types of software, including: games, educational, utility, etc.

## Stand 3

**Golem Ltd., 77 Qualitas, Bracknell, Berks RG12 4QG. Tel: 0344 50720.**

Golem is a small company of computer experts who specialise in developing quality software for the BBC Micro and Electron. Their range covers educational software, adventure games and utilities.

All the software has been produced with care and attention given to details. This practice was especially important whilst they were preparing their educational programs, which are now used in hundreds of schools throughout the country.

The cassette titles include: EDUCATIONAL 1, EDUCATIONAL 2, FUN WITH WORDS, GAMES OF LOGIC, SUPERLIFE, KATAKOMS and UTILITIES. All are available in disc form.

## Stand 4

**Softspot, 29 South Crescent, Prittlewell, Southend, Essex. SS2 6TB. Tel: Southend 347211.**

Who says business is all work and no play? Come to the

Softspot stand and have a go with our new, original computer games. Defend your bank from daylight robbery in "Heist"! Protect your computer from self destruction in "Transistor's Revenge"! And next? Be warned, Fruity Freddy is coming! These games are intriguing, addictive and have ENORMOUS SALES potential. Especially developed for the BBC Micro computer they feature dramatic graphics and present the player with the ultimate in 'challenge'. For full details see Chris Butler on Stand 4.

## Stand 5

**Computer Agencies Ltd., 29 Sun Street, Hitchin, Herts.**

Computer Agencies Ltd have on display a graphics planner for the BBC Micro and Acorn Electron known as 'PIXEL PAD'. Each pad contains 50 A3 sheets, each sheet comprising a screen layout showing every print and plot co-ordinate and twelve 8 x 8 User Defined Graphics Grids. On the back of the cover is a useful summary of graphics commands. Also on display is a handy A5 pad containing 800 User Defined Graphics Grids.

## Stand 6, 134

**R.H. Electronics Sales Ltd., Chesterton Mill, French's Road, Cambridge CB4 3NP. Tel: 0223 311290. Telex: 817936.**

Products on show will include the very popular Light Pen approved by Acorn Computers with the new Graphic Pack. The full range of R.H. Software will be available and your visit to the show will not be complete until you see the exciting new Video Digitiser and DCP range of control products for the BBC Micro. During the show we will be offering lots of Christmas bargains on Light Pens (including free software Lucky Dip) and software packs.

## Stand 7

**LCL, 26 Avondale Avenue, Staines, Middx. TW18 2YN. Tel: 0784 58771.**

LCL specialises in educational software and have over 200 programs available. They are showing their best-selling Micro Maths, a complete Maths course to O-Level of 24 programs, and their programs for younger children from age 3. Adults are also catered for as well, as they have an eagerly-awaited book, 'Brainteasers for the BBC and Electron computers' on the stand for the first time, an ideal Christmas present for those with enquiring minds. They are also launching the new improved version of Picture Puzzles at this exhibition. Generous trade discounts and return-of-post delivery is available for dealers.

#### Stand 8

**British Micro**, Penfold Works, Imperial Way, Watford, Herts. WD2 4YY. Tel: 0923 48222.

British Micro, a Hegotron group company, manufactures and markets the Mie Mie 804 family, continuing the line of British designed and manufactured Micro-Computers first introduced by British Micro in 1981. All Micro-Computers in the 804 family support full colour and text mode.

In addition all Micro-Computers in the 804 family support the newly introduced Grafpad from British Micro.

Selling at £125.00 plus VAT, Grafpad is the affordable tablet for the BBC Micro, with adaptors for other home computers in the pipeline. This is the first low-cost graphic-tablet to offer the performance and durability required for business, industrial and educational applications. It is small, accurate and reliable, and needs no adjustment or preventative maintenance.

#### Stand 12

**OIC Ltd.**, 15 Burghead Close, College Town, Camberley, Surrey, GU15 4XL.

A new company on the micro scene – OIC was the brainchild of three experienced computing professionals who met while working together on a project at the British Computer Society.

The original idea of the company was to produce high quality educational software (hence the name of the company), catering for all ages and any intellects, ranging from pre-school teaching aids, through computing appreciation, onto business training aids, although we are now also developing other products with less educational appeal. Our complete product range will consist of:- text (simulation) games, early learning, adventure games, computer tutorial, graphics games, tools and utilities and business applications.

We specialise in producing quality software for the BBC B. All of our products will initially be developed on the BBC B, conversions for the other popular machines following later. Products on show:- Dodgy Dealer – business simulation, Sort Animator – the first of our computer tutorial series, Grab Cash and Dash – a new style of adventure.

#### Stand 13

##### **MUG's (Micro User Groups)**

This stand is provided by THE MICRO USER magazine and is run for the User by the User. It provides a focal point where people can exchange ideas and discuss problems. Come and meet other users in an informal atmosphere on this stand!

#### Stand 14

##### **Oxford Microware.**

Oxford Microware Ltd is a rapidly expanding educational software house based in the University city of Oxford. The aim of the company is to produce highly sophisticated educational software for use on the BBC microcomputer. Programs are conceived by a team of educationalists and teachers and written by professional programmers.

They are extensively tested in the classroom and are supplied with full documentation and teaching notes. A sample of recent programs is available for demonstration on Stand 14.

#### Stand 15

**MYB Software**, Tel: 01-455 2814.

After many months of development MYB Software will be launching its Hebrew ROM for the BBC Micro. This ROM has already been selected as a standard option for all BBC Micros sold in Israel. On show will be demonstrations of graphics and word processing in Hebrew, the latter using a standard Acornsoft 'VIEW' ROM.

Also on display will be our exceptionally versatile and easy-to-use Disc Menu Creator Flash Editor System. This disc package includes a 'hidden' auto-boot file and will give any disc-system the 'professional touch'. MYB Software will not be exhibiting on Friday afternoon or Saturday for religious reasons.

#### Stand 16

**Micro-Aid**, 25 Fore Street, Praze, Camborne, Cornwall. TR14 0JX. Tel: 0209 831274.

Micro-Aid was formed in 1978, the aim of our name being to help people understand how to use the micro by giving 'AID'. PAYROLL, SPELL-CHECK, CASHBOOK, MEMO-CALC, MAILING, STATISTICS, UTILITIES, FLAGS, DISTANCES, GAMES. All valuable programs written by ourselves for you. High prices don't make good software – good understanding programmers do.

Our software costs under £18 and in some cases is as low as £1.00. The range includes utilities, games, educational and business programs and we are offering more and more hardware such as Epson printers, Teac disc drives and ROMS. We know your problems and are pleased to help you.

#### Stand 18

**Microvitec**, Futures Way, Bolling Road, Bradford, West Yorkshire. Tel: 0274 390011. Steve Pearce, Len Campey, Christ Moore.

Microvitec, the manufacturers of the well known Cub Colour Display are exhibiting their full range of RGB monitor products for the BBC Micro. Visitors to the stand will be able to see and compare standard, medium and high resolution displays in both metal and plastic cabinets.

Also on show will be the new Composite Video/RGB monitor, ideally suited to owners of both the video cassette recorder and the BBC Micro.

#### Stand 21

**Superior Software Ltd.**, Dept MUS, 69 Leeds Road, Bramhope, Leeds. Tel: 0532 842385.

Why "Superior Software"? Because our software is the best available for the BBC microcomputer.

"Hunchback", "Road Runner" and "Frogger" are now rightly recognised as being classic examples of BBC micro software at its best. We are now releasing 6 new programs: "Crazy Painter", "2002", "Fairground", "Star Trek Adventure", "Lost City", and "Gideon's Gamble". Once again, we confidently expect a string of excellent reviews.

All our programs are on continuous demonstration here at the exhibition... so come and give them a try! Meet our friendly sales team and pick up our latest catalogue. We're sure you'll be pleased with our superior software.

#### Stand 30

**Viglen Computer Supplies**, Unit 7, Trumpers Way, Hanwell W7. 2QA. Tel: 843 9903/1.

Viglen Computer Supplies offer the best service and value in disc drives. We offer the latest range of Teac Mitsubishi and Canon drives as well as special bargains for the first time buyer. We hope to be able to offer during the exhibition a disc drive plus interface including VAT for under £200 complete.

From our 10,000 sq ft factory in West London we manufacture all our cases, leads and accessories in order to supply at the most competitive prices.

#### Stand 35

**Display Distribution Limited**, 35 Grosvenor Road, Twickenham, Middlesex TW1 4AD. Tel: 01-891 1923/1513. Telex: 295093.

Display Distribution will be exhibiting the Novex range of monitors designed for use with the BBC micro. The range comprising colour and monochrome are housed in metal cabinets, and finished in BBC colours. The star of the range is the NC-1414-CL standard resolution colour monitor, having RGB and PAL inputs including sound, together with a green text button for data presentation at a price of only £199.95 + VAT. This is the best value colour monitor on the market. Medium and high resolution models will also be on show. Stocks will be available at the exhibition for purchase. Barclaycard and Access will be accepted.

#### Stand 37

**MW Systems Ltd**, Matrix House, Lincoln Road, Cressex Industrial Estate, High Wycombe, Bucks HP12 3RD. Tel: 0494 450341. Telex: 837600.

MW Systems are fast establishing themselves as a leading supplier of disc drives and Winchester sub-systems in the micro market. By supplying only end users and the education market they keep prices down but still offer a guaranteed seven day repair or replacement time on equipment.

#### Stand 38

**Microware (London) Ltd**, 637 Holloway Road, London N19. Tel: 01-272 6237.

Microware, the authorised dealers for the BBC Micro, offer a complete range of BBC compatible products including disc-drives, controllers, monitors, printers etc. Look out for our new range of ZL disc drives sub-systems with capacities up to 1.6 Mb. Our unique double density disc controller out-does all its competition and is already in great demand.

Our new disc-drive from CDC eliminates the need for any controller – ask for details on our stand No. 38.

#### Stand 39

**Electron User**, Europa House, 68 Chester Road, Hazel Grove, Stockport SK7 5NY. Tel: 061-456 8383.

The New Year sees Electron User leaving the shelter of its elder brother, The Micro User, and starting life as an independent magazine.

To celebrate we've taken a stand at the show to tell people our plans and to allow new Electron owners to catch up with our first

four issues.

These back issues will be on sale at a special price of £1 for all four. Also we'll be selling a tape containing all 26 programs that have appeared in the first four issues of Electron User. Those of you wise enough to take out a subscription will receive the tape for free!

If you have an Electron or are thinking about buying one then come along to the stand and have a chat about what you want from Electron User.

#### **Stand 44**

**CJE Microcomputers**, 25 Henry Avenue, Rustington, West Sussex, BN16 2PA. Tel: 0903 213900.

CJE Micros will be launching the 10X dot matrix printer at the show. The full range of Star and Jukei printers will be on display. The printers will be available at special show prices with screen dump software for the BBC included.

#### **Stand 45**

**National Micro Centres**, National House, 36 St. Petersgate, Stockport, SK1 1HL. Tel: 061-480 4523.

National Micro Centres will be demonstrating the Torch Disc Pack, which for only £730 plus VAT upgrades your BBC to a full scale business machine and makes available the enormous range of CP/M software. Included in this price is more than £1,000 worth of word processing, spreadsheet and database software and also a sophisticated management game.

You will also be able to see Micronet demonstrated. Micronet allows you to access Prestel and communicate through your computer over telephone lines with other users. You can purchase the necessary software and hardware and subscribe to Micronet at the stand at special show offer prices.

There is also a wide range of accessories, many at special show prices. Special offers include the BBC starter pack, the disc users starter pack and special savings on BASF discs.

#### **Stand 46**

**Concerned Technology**, Dept. of Trade & Industry, Information Technology Division, 29 Bressenden Place, London, SW1E 5DT.

The Concerned Technology is the name given to a travelling exhibition which sets out to show how information technology can provide devices to help those with special needs. Information Technology is the micro electronics based combination of telecommunication and computing.

Available for you to try are a large number of aids which are commercially available, together with some new projects developed by individuals, groups and educational establishments.

If you are considering developing an IT aid for commercial manufacture, the DTI may be able to provide help in the form of advice or cash grants.

For more information write with brief details of your proposal to:- John McCann, Dept of Trade and Industry, Information Technology Division, 29 Bressenden Place, London SW1E 5DT.

#### **Stand 49**

**Software Invasion**, 2 Iffley Road, Hammersmith, London. Tel: 748 2302.

Are you the sort of person who can sustain the concentration needed to fly a Starfighter through asteroid storms, picking off fleets of aliens into the bargain? Or maybe you fancy the role of a gunner in the Royal Navy, protecting a fleet of ships from hostile air attack. How about warding off swarms of alien killer wasps intent on invading your planet? You may even prefer to become a "Law Man" in the Wild West, helping to rid a shanty town of marauding bandits. Come and see the Software Invasion stand for a new experience in 3 dimensional action!

#### **Stand 51**

**Senator Software Ltd**, 44 Worcester Crescent, Mill Hill, London NW7 4LL. Tel: 01-959 5616.

A company which has concentrated on providing a practical consultancy service for computer applications. They have recently entered the home computer market (currently BBC, Spectrum and Commodore 64) and in addition to producing their own packages can offer constructive advice and in-house software to programmers wishing to implement their own packages. Senator Software in conjunction with Stake Media Services is also able to offer a full range of computer consumables (listing paper, cassettes, discs etc.), furniture and office supplies, featuring such brand leaders as 3M, BASF, CDC, ACCO and Rexel.

#### **Stand 57**

**Bucon Ltd**, 18 Mansel Street, Swansea, SA1 5SG. Tel: 0792 467980.

Bucon Limited designs and markets several products for the

BBC computer under the name of Merlin Computer Products.

On show will be the Merlin Scribe, a superb professional word processor. The program is supplied in chip form and is the only word processor currently available specially designed for the BBC disc system. Also on show is a new SUPER LOGO providing considerable advantage over present examples of the language. Merlin offers single and dual slimline 100/200 Kb disc drives with double density capability at a low price, and a real time clock giving a high level of timing precision with a life expectation of five years.

#### **Stand 58**

**MGB Software Support Ltd**, 52 Barley Croft, Harlow, Essex. Tel: 442252.

MGB Software Support Ltd., will have their full range of software, concentrating mainly on utilities. These include a full set of disc utilities, and a flexible, automatic menu program. Frameup and Beebtext a screen generation and display system, and the cassette base Epson Screen Dump. Also for sale will be two games - Robobrain and Gobbler. These are available on cassette and disc. Also on display will be the Epromer, a combination of an Eprom Programmer and an extension to the Sideways ROM's, and supporting software.

#### **Stand 59**

**Akhter Instruments**, 28 Burnt Mill, Harlow, Essex. CM20 2HU. Tel: 0279 29097.

Akhter Instruments will be offering the best prices on peripheral equipment for the BBC eg: monitors, printers, disc drives and lots of other special offers. A new sideways rom extension and prom programmer unit will also be on display.

#### **Stand 64**

**Micro Power**, 8a Regent Street, Chapel Allerton, Leeds, LS7 4PE. Tel: 0532 458800.

This Leeds based company will be at the exhibition in force to show off its complete range of over 50 titles, including 3 new games: Zarn, Martian Attack and Cybertron Mission, all at £7.95 each.

These and several more games will be ready to play on the demonstration stand. Eleven titles, including Cybertron Mission, will be on sale for the Electron. This is the first batch of programs to be converted from the best-selling range for the BBC.

#### **Stand 70**

**Master Class Video Cassettes**, 172 Finney Lane, Heald Green, Cheadle, Cheshire. Tel: 061-437 0538.

Learn how to use and program the BBC Micro, Acorn Electron or Sinclair Spectrum. Video tape instruction clearly showing how you can write your own programs in Basic. For the beginner building up to the more advanced. Graphics, animation etc also covered. The example programs shown on these video tapes can be transferred to your cassette recorder and loaded into the computer.

#### **Stand 71**

**Opus Supplies**, 158 Camberwell Road, London SE5 0EE. Tel: 01-701 8668.

Opus Supplies on Stand 71 will be launching their latest offer - the JVC 14" fully cased monitors - at £149.95 for medium resolution, and £229.95 for high resolution - they are less than half the recommended price for this product. We will also be selling 5¼" and 3" disc drives complete with all leads etc. ready to plug into the BBC Micro. All the drives are double density and we have a full range of single drives available up to 1Mbyte and dual drives all with their own power supply at special discounted show prices. With green screen monitors, games, floppy discs and desks Stand 71 is well worth a visit.

#### **Stand 72**

**Miniature Tool Company**, 26 Queensbury Station Parade, Edgware, Middlesex. Tel: 01-951 1183.

The Miniature Tool Company are leading suppliers of accessories Microcomputer. These include all I.D.C. sockets, "D" Connectors, printer cables and disc drive leads. We are also major suppliers of blank cassettes. Trade and overseas enquiries are welcome.

#### **Stand 3**

##### **The Electronic Classroom**

In our Electronic Classroom you will be able to see the use of the UTAC Video Control Unit in a real-life teaching situation. Keyboard Training will be using this equipment to demonstrate their TechniTouch Computer Keyboard Training Programme.

This exhibit shows the application of all-British technology to replace the conventional blackboard and chalk with a computer video screen. We are indebted to Fairhurst Instruments of Wilmslow for the loan of the computers and to Cumana for the disc operating systems.



**THE  
BBC  
MICRO  
USER  
SHOW**

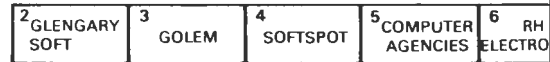
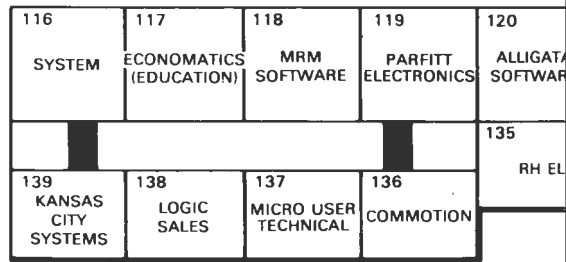
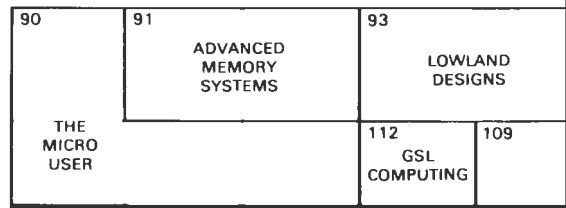
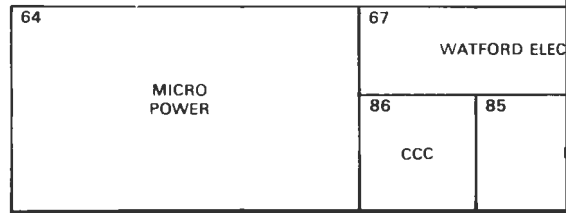
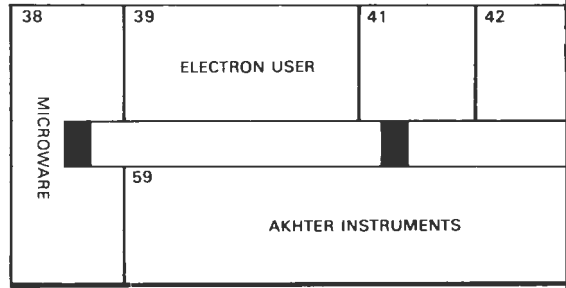
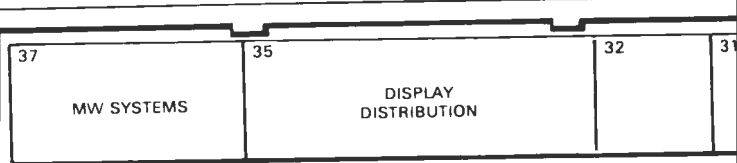
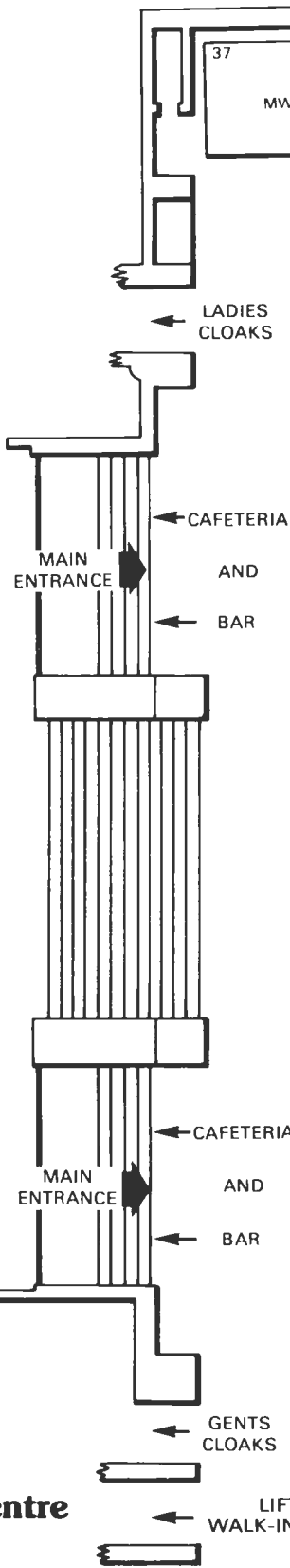
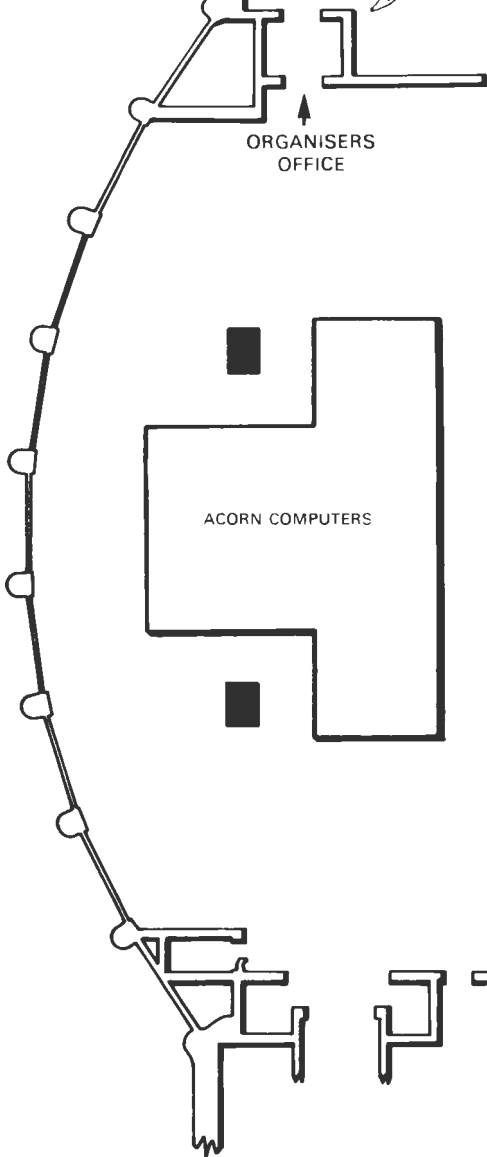

**Westminster Exhibition Centre  
Greycoat Street  
London SW1**

**December 8, 9, 10, 11, 1983**





Stand details may be slightly changed, but were correct at the time of going to press

#### Stand 75

**Watford Technical Books**, 105 St. Albans Road, Watford, WD1 1RD. Tel: 0923 23324.

The BBC Microcomputer Disc Companion by Tony Letham, Advance Programming Techniques for the BBC Micro by Jim McGregor and Alan Watt, and loads of other best selling books for sale.

Watford Technical Books is a bookshop which specialises in Computing and Electronics. We run a mail order and phone order service, and now Prestel and Micronet users can browse through and order from our lists of over 1,000 computing books from publishers in Britain and America. Key 28844 for a WTB Index on Prestel.

#### Stand 76

**Oak Software**, 71 Woodlands Road, Hertford, Hertfordshire. Tel: 0992 58258.

Oak Software were formerly trading as Deskflair. We produce and market games for the BBC microcomputer. Our very large range of games range from adventure and arcade type of games to the educational type; something for the whole family. Our latest games have been receiving excellent reviews. Come and visit us at Stand 76. Browse around and we will do our best to answer all your questions. Trade and overseas enquiries welcome.

#### Stand 77

**Electronequip**, 36-38 West Street, Fareham, Hants. PO16 0JW. Tel: 0329 230670.

Electronequip of Hampshire have been suppliers of Acorn products since the introduction of the Atom. They have introduced several of their own products on to the market: Micro Disc Drive: 3" 80K micro disc drive faster than many 5¼" disc drives yet only costs £113.00 + VAT. Drive and interface costs £173.00 + VAT. TV/Monitor: TV/Monitor is a television that has been designed so that it can be used as a monitor as well as a TV. Cost £220.00 + VAT (£253.00). A remote version is also available for £235.00 + VAT (£270.25).

Electronequip spacious premises at West Street Fareham include 20 station Econet and Torchnet systems which are on demonstration six days week from 9am to 5.30pm as well as extensive stocks of BBC software and peripherals.

Electronequip pride themselves on their after sales service and technical support. They provide courses on subjects such as Econet. Electronequip supply hobbyists, small business, industry, educational establishments, government establishments and dealers. They are distributors for printers, monitors and disc drives. Their fully computerised order processing system enables them to offer a same day despatch mail order service on their full product range. Dealer enquiries welcome on most products.

#### Stand 81

**BBC Telesoftware**, Broadcasting House, London, W1A 1AA.

The new BBC Telesoftware service will be on display, using a BBC Model B microcomputer and the Acorn teletext adaptor. With this equipment users can obtain free software delivered as part of the CEEFAX service on BBC 1. Many of the programs are interactive, using data grabbed from the normal CEEFAX pages as a base for further calculations.

#### Stand 83

**C-Tech Computers**, 184 Market Street, Hyde, Cheshire. Tel: 061-366 8223.

C-Tech Computers is a large company based in Hyde, Cheshire specialising in all aspects i.e. hardware and software for the BBC Microcomputer. We offer extremely good quality goods at very competitive prices. At the show our main attraction will be a range of second processors for the BBC Micro. We shall also have large stocks of disc-drives and printers at excellent prices. Whether you are looking to expand your BBC or you are a first time computer buyer, come and see us on the stand where our highly trained staff will be more than pleased to offer you friendly, and we hope, useful, advice.

#### Stand 90

**The Micro User**, Europa House, 68 Chester Road, Hazel Grove, Stockport SK7 5NY. Tel: 061-456 8383.

There's a treasure house for readers of The Micro User on this, our most exciting stand ever!

We've got all the back issues of Micro User, so you can stock up on those vital articles you may have missed. And our latest issue will be there, hot off the press.

Of course we'll be featuring our whole range of Micro User cassettes, so you can save yourself the chore of typing in the scores of fascinating programs presented in the magazine.

And, for the first time ever, we'll be selling the complete range

of Micro User programs on disc!

Another new product is the Micro User holdall, by far the safest way to transport your micro system.

We're also featuring the complete range of Beeb Body Building packs – the answer to all your interfacing problems.

You'll be able to buy, ready built, the Micro User Light Pen and the revolutionary Sound to Pattern Converter.

All in all, The Micro User Stand, like the magazine, is an exciting must for all BBC micro users.

#### Stand 91

**Advanced Memory Systems**, Green Lane, Appleton, Warrington, WA4 5NG. Tel: 0925 62907.

AMS will be selling the Hitachi 3" disc drives. The ultimate disc drive package, tailored to your BBC Micro, it is compatible with all disc interfaces and includes cables and comprehensive manual and utilities on disc and Eprom. Housed in a steel case, matching the BBC Micro, these reliable and robust Hitachi 3" disc drives are the ultimate for home, office and classroom.

#### Stand 95

**Educational Computing**, Durrant House, 8 Herbal Hill, London, EC1 5EJ. Tel: 278 6552.

Educational Computing is essential reading for all teachers who want to keep in touch with the use of computers in education. Every month we publish extensive reviews of software and books, regular features on specific subject areas and a guide to educational software for the most popular micros (BBC, Spectrum, 380-Z, etc) as well as surveys covering such topics as administration, networks and disc drives. Plus, of course, up to date coverage of new equipment and programs.

The current issue includes a review of different monitors, a feature on special education and information on school's and commercial television and radio broadcasting.

#### Stand 96

**Kirklands Computer Centre**, Kirkland House, 27 City Road, Fenton, Stoke on Trent, ST4 1DP. Tel: 0782 415787.

Kirklands Computer Centre is an official LVL/Acorn computer dealer and specialises in the supply of BBC, Electron, and all associated peripherals. On show will be their new 14" Colour TV/monitor which is at least equivalent to most medium resolution monitors.

Kaydee Software is an associate company of Kirklands Computers and are not new to the pages of the Micro User. Reviews of most of their current software have been in the March, August, September and October copies of the Micro User.

#### Stand 97

**Twillstar Computers Ltd**, 17 Regina Road, Southall, Middlesex. Tel: 01-574 5271.

Come to Twillstar Computers Ltd, demonstrating the full range of BBC home computer hardware and software for schools, houses and small businesses. The main exhibits are the BBC Microcomputer, Acorn Electron, the Logitec Printer Shimwa CP80, Mannesmann, Epson, Suki, Brother. Monitors covering Phillips 2P 200 green monitors, Noromende 14" TV/monitor, Torch disc packs, slim disc drives, Teak SSA and Mitsubishi, Komori. Floppy discs, joysticks, cassette recorders. Come and see our software on adventures, languages and education. Pick the book that suits your need. Come to stand number 97.

#### Stand 101

**C/WP Computers**, Willow House, Willow Place, London, SW1P 1JH. Tel: 01-828 9000.

C/WP will be offering a wide range of peripherals for home computers. In addition, specialist business systems will be demonstrated, featuring WordStar and dBase II. Peripherals available for sale include Epson printers from £289 inc. VAT; Star printers, £249 inc. VAT; Silver Reed daisy wheel printers £299 inc. VAT; floppy discs from £13 inc. VAT; disc drives for the BBC, £178 inc. VAT.

#### Stand 105

**Optima Software**, 36 St. Petersgate, Stockport SK1 1HL. Tel: 061-456 8836.

Optima Software, one of the newest software houses on the BBC Micro scene, has chosen the Micro User Show for its first public appearance.

Five of their releases will be on show – two utilities, Datext and Optimom, and three games.

Optima will also be previewing some of their future programs. As befits a firm where two thirds of the workforce are qualified teachers, Optima intends to concentrate on the educational

market and are keen to raise the standard of educational software.

#### Stand 106

**Micro Resources Ltd**, *Southfield House, 11 Liverpool Gardens, Worthing, BN11 1RY. Tel: 0903 213174.*

On display is a new 3" disc drive for the BBC Micro with completely protected hard cased disc. Single drive at £149.00 + VAT. Dual drives at £249.00 + VAT. Very easy to upgrade single to dual. Also on display is a very competitively priced colour monitor made by Cabel Electronic retailing at £199.50 + VAT. Finally there is a new ROM that converts a BBC Micro into a VT 52 and Textronic 4010 emulator terminal.

#### Stand 109

**Pace Software Supplies**, *130 Clayton Road, Bradford, BD7 2LY.*

Demonstrations of E-net, the new Acorn Winchester based educational networking system for the BBC Micro. Each station can have its own printer. Plus the full range of PACE 5¼" floppy disc drives.

#### Stand 112

**GSL Computing**, *2 North Way, Andover, Hampshire. Tel: 0264 51699 or 58744.*

GSL Computing (official Acorn dealer and service centre) stockists of all major peripherals, announce a remarkable breakthrough in the expansion of computer capacity. The GSL E/Net Winchester networking system incorporating the BBC microcomputer, specially designed for education use. E/Net allows up to 200 computers to share a common, large centre disc store and overcome many of the inconvenient features of earlier network systems. GSL are also suppliers of the Shugart D range of disc drives and believe the 100K drive to be the cheapest in the country. For further details and prices please contact us at our Andover office.

#### Stand 116

**System**, *12 Collegiate Crescent, Sheffield, S10 2BA. Tel: 0742 682321.*

System offers the best in educational software and programming utilities. For the computer musician there is the now famous Music Editor – hasn't been bettered yet! and Envelope Generator which interfaces with it.

New and available now – ADE – our macro assembler/Editor/Word Processor incorporating SPY debugging monitor all on 16k ROM. SPY also available separately.

Schools Administration packages and teaching programs here for demonstration and sale. See Multitest, the latest in language testing programs. If you want the best in BBC software, come to us. Discs – you won't get a better price! Large range of BASF discs available at the show.

#### Stand 117

**Economatics (Education) Ltd**, *4 Orgreave Crescent, Dore House Industrial Estate, Handsworth, Sheffield, S13 9NQ. Tel: 0742 690801.*

The BBC Buggy, a three-wheeled robot controlled by a BBC microcomputer, is featured on Stand 117 by education equipment specialists Economatics (Education) Limited, of Sheffield.

Since its official launch in September the BBC Buggy has become increasingly popular among schools eager to advance their computer studies, and home computer enthusiasts. The BBC Buggy pack, which sells at around £190 (including VAT) consists of a simple-to-build fischertechnik construction kit and all the software required to program the friendly robot. The BBC Buggy forms a useful complement to studies involving the skills of planning, estimating, measurement, sequencing and problem-solving.

#### Stand 118

**MRM Software**, *17 Cross Coates Road, Grimsby, South Humberside, DN34 4QH. Tel: 0472 44304.*

MRM Software were originally set-up to distribute software via Micronet 800. Due to overwhelming response to Micronet they decided to sell direct to the public. Now they are a company that sell high quality software. On their stand MRM will be selling all their tapes at £4.95 per game.

#### Stand 120

**Alligata Software**, *178 West Street, Sheffield, S1 4ET. Tel: 0742 755005.*

Exciting new programs for the BBC Model B and Electron are being launched for the first time by Alligata Software of Sheffield at the BBC Micro User Show.

Alligata have already established a strong reputation for high quality games and home/business utilities. Features of their

games are the application of fast-action machine coding, top-quality graphics and imaginative sound effects. These features have been continued with the new range of programs now being launched: Electron – Bugblaster, Lunar Rescue, Fruit Machine, Primary Art, Primary Time. BBC Model B – Eagle Empire, Neanderthal Man, Dambusters, Bridge, Primary Art, Primary Time.

#### Stand 122

**Techneg Clwyd Technics Limited**, *The Coach House, Kelsterton Road, Flint, Clwyd, CH6 5TH. Tel: 0244 816236 or 810518.*

Clwyd Technics Limited markets, manufactures and distributes a wide range of computer software and hardware. Its latest product EDWORD is the only educational word processor designed by teachers for pupils to use. Developed by MEP, EDWORD runs on any BBC microcomputer, works with any compatible printer and electronic typewriter, and its storage system can be tape, disc and networks. Special features include clarity, simplicity of use, unique 'error help' facilities, display of the text as it will be printed and easy formatting. No previous knowledge of word processing is necessary to use EDWORD and it can be used for commercial and home as well as educational applications.

#### Stand 123

**Clares Micro Supplies**, *222 Townfields Road, Winsford, Cheshire, CW7 4AX. Tel: 06065 51374.*

Clares Micro Supplies are the leading suppliers of disc utility software for the BBC Micro. In addition we will also be exhibiting our other utility and educational software. New programs since the last show include 'SHADOW' which is a useful tape backup system which allows users to make security copies of most cassette programs.

New releases on show will include REPLICA II which is the latest development in the highly acclaimed and successful REPLICA series – come and see for yourself just how much tape software can be transferred to disc with REPLICA II. We also hope to have our new disc orientated program, B-BASE, on show and it must be seen by anybody needing a real database.

#### Stand 127

**Computer Concepts**, *16 Wayside, Chipperfield, Hertfordshire. Tel: 09277 69727.*

Computer Concepts will be selling the ever-popular WORDWISE and DISC-DOCTOR packages, as well as the latest addition to the range – TERMI.

The new GRAPHICS EXTENSION ROM will be on demonstration for the first time in public, as well as a very advanced VT 100 terminal emulator called COMMUNICATOR for the more technically minded. Visitors to the stand will be able to take advantage of our special show discounts as well as having an opportunity to ask all the awkward questions we dread!

#### Stand 129

**Integrex Ltd**, *Church Gresley, Burton on Trent, Staffs, DE11 9PT. Tel: 0283 215432.*

Colourjet, a new colour ink jet printer for the BBC Micro, is on display. Colourjet is supplied complete with software listing for high resolution colour screen dumps, as well as normal data printing from the BBC Micro. A teletext interface card is also available which becomes a normal RS 232 interface under software command.

Colourjet is now available at a price of £499 + VAT.

#### Stand 132

**Educational Software**, *41 Trafalgar Road, Birkdale, Southport, Lancs.*

Demonstrating an amazing colour light-pen with which you can write, paint and draw on the BBC Model B screen. Routines are available for using the pen in your own programs. Pictures can be saved, and reloaded. They can also be used in your own programs. Graphics facilities are also available within the program and it is possible to draw/plot lines, triangles, rectangles and circles. Finally, text upper and lower case may be added to your pictures.

This pen has tremendous educational potential with programs being developed in the primary field for teaching writing skills and for developing logical thinking through classifying and sorting objects on the screen. In the secondary field programs for curve plotting, tabulation, gradient calculation and co-ordinate finding, as well as distance, and enclosed area calculation are also under development. A music synthesiser program with part of a keyboard displayed, and played by a choice of 14 different

sounds (such as piano and bells), four tempos, four octaves and harmony.

A database program with the cross-tabulation features of SP + SS is also being shown. It's presently in use with a number of local authorities. This is probably one of the most useful and powerful databases presently available for the BBC Micro. It can be purchased first as a general database for the everyday user, and then later the tabulations/correlations program may be added if required. A range of other educational software is available.

#### Stand 133

**Cumana Ltd., Unit 1, Pines Trading Estate, Broad Street, Guildford, Surrey, GU3 3BH. Tel: 0483 503121.**

Cumana is the UK's leading floppy disc drive distributor, and has reached this impressive position on one watchword – quality. From top quality designs to the very best Japanese components and British manufacturing skills, everything must be of the highest standard.

Cumana produces a comprehensive range of products at unbeatable value for money prices and the company's slimline disc drives for the BBC Microcomputer are now available from well known high street outlets as well as from Cumana's extensive dealer network.

We are the market leaders and intend to stay there, so you can be sure we will still be around when others disappear!

#### Stand 136

**Commotion, 241 Green Street, Enfield, Middlesex, EN3 7SJ. Tel: 01-804 1378. Telex: 299872.**

Commotion is a dynamic new company specialising in the control and robotics field. In August we launched "THE BEASTY", the interface for controlling servo motors accurately from the BBC 'B'. Because of the BEASTY'S low cost and the flexibility of servos, robotics are now within everyone's budget.

Commotion has already expanded with a new range of products from SJ Research, including the famous R2 unit which allows mains control from the BBC 'B'.

Newly launched at this show will be "The Control ROM", the

only ROM of its type available. So come and see the Commotion on Stand 136.

#### Stand 137

##### Technical Advice Stand

Here's your chance to ask all those questions that have puzzled you about the BBC Micro.

Our team of experts from the magazine – Mike Cook, Jim Notman and Paul Leman – will be on hand to sort out any technical queries you might have about the BBC Micro.

We can't promise to be able to answer everything – but we'll have a real good try!

We'll also be demonstrating the Link Up method of joining two BBC Micros together – an exciting idea you shouldn't miss.

#### Stand 138

**Logic Sales, 35 Downfield Road, Cheshunt, Hertford, Herts. Tel: 0992 33117.**

Logic Sales Ltd, is a specialist home-computer store stocking a wide range of computers and peripherals, and probably the largest range of software in North London. They also market the Spectre Soft Software which includes the popular Mission-Om, Crisis Countdown and Strike 4. Logic has recently started merchandising a number of stores with software, offering to replace all non-mailing lines with current best sellers on a weekly non-delivery/collection basis. Logic will be showing a large number of products at special show discounts of over 20 per cent on most software.

#### Stand 139

**Kansas City Systems, Unit 3, Sutton Springs Wood, Chesterfield, S44 5XF. Tel: 0246 850357.**

Kansas is one of the oldest-established software publishers in the UK and attends all major exhibitions. Visit our stand for some special offers.

We are using the show to launch new titles in our renowned Arcade series of fast action games and will also be offering educational and utility software for the Beeb.

Kansas offers a same-day postal service on goods as well as lifetime guarantee on all its software.

# Increase your fire power!

See it on  
Electronequip's  
and  
Watford electronic's  
stands.

## More than just a joystick.

A superb joystick and a keypad for the price of either. Plus the software to integrate it into the computer's systems.

★ 12 Months Guarantee.

DELTA DRIVER on cassette or disc: Two programs on each cassette or disc. One diverts machine code programs from the keyboard to the joystick or keypad, with adjustable sensitivity on the joystick and will run on any O.S. The second program (needs O.S. 1.0 or later and an adaptor box) duplicates any keyboard keys on the keypads, in the operating system, so that it can become a numeric keypad or will take on the function keys.

## Voltmace Ltd

PARK DRIVE, BALDOCK, HERTS. SG7 6EZ.

Tel: (0462) 894410

Callers welcome at the factory – Monday to Friday

## Complete control at your fingertips.

- Nylon encased – Steel shafted joysticks with ball and socket joint
- Fast spring return to centre
- Graphite wiper linear potentiometers

One handset will work on it's own in the A/D port as a joystick and two fire buttons. Joystick is immediately compatible with ACORNSOFT and similar software.

The adaptor box joins together the analogue and the user ports to use the full keypad giving a total of 24 user definable keys. The adaptor box can also be used as a splitter for the A/D port to take two items at the same time, e.g. joystick and lightpen.

# Voltmacedelta 14b

# electron user



## The end of the beginning!

Next month *Electron User* becomes a completely separate magazine. And this means you get . . .

- Lots more packed and colourful pages devoted solely to the Electron.
- Lots of listings of games, utilities, graphics, education – in fact the whole range of Electron computing.
- Lots of easy to follow features on everything to do with the Electron. Beginner or expert you'll find something fascinating within its pages.

### PLUS

- Expert reviews of all the new books, software and hardware – if it's for the Electron you'll find all the facts you need in *Electron User*.

electron  
user

The most exciting computer magazine yet.

If you've got an Electron – or about to get one – let *Electron User* show you how to make the most of it.

### SPECIAL OFFER!

FREE cassette of 26 programs  
from the first four issues  
of *Electron User*  
– worth £3.75  
– order NOW!

**SUBSCRIPTION FORM** – Please send me the next 12 issues of *Electron User* at the special introductory offer inclusive price of £12.  
Special offer applies to UK readers only. Overseas Airmail £30. Surface £15.

Name \_\_\_\_\_ Address \_\_\_\_\_  
Card No. \_\_\_\_\_ Expiry Date \_\_\_\_\_  
Signed \_\_\_\_\_  
Payment: please indicate method (✓)  
 Access/Mastercharge/Eurocard  
 Barclaycard/Visa  
 Cheque/P.O. made payable  
to Database Publications.  
Send to: Database Publications,  
FREEPOST, Europe House,  
88 Chester Road, Hazel Grove,  
Stockport SK7 5NY.  
(No stamp needed  
if posted in UK)



# EDWORD

## EDucational WORD processor system

**EDWORD** The only word processor designed by teachers for pupils to use.

**EDWORD** Setting new standards in educational software.

**EDWORD** Has many features of commercial word processing systems.

**EDWORD** Superb documentation. Easy to follow. Easy to use.

**EDWORD** Developed by the Microelectronics Education Program for the BBC computer.

**EDWORD** Will run on Model A or B, tape or disc, stand alone or networked.

**EDWORD** Available from:

**EDWORD** sales department

**CT** **TECHNEG CLWYD TECHNICS LIMITED**

Unit 4B, Antelope Industrial Estate, Rhydymwyn, Nr. Mold,  
Clwyd CH7 5JH. Telephone: Hendre (035283) 766

3M Distributor. Official dealer for the BBC, Acorn, Zenith and Torch hardware, and  
Acorn, BBC, Gemini and Psion Software.

FREE COMPETITION

# Can you spot Electron Eddie?

See how many cards like this you can spot on the various stands.

All correct entries will go into a hat and will be drawn twice a day on the Electron User stand.

The winners will get a bag full of BBC Micro or Electron goodies!

*Happy hunting!*

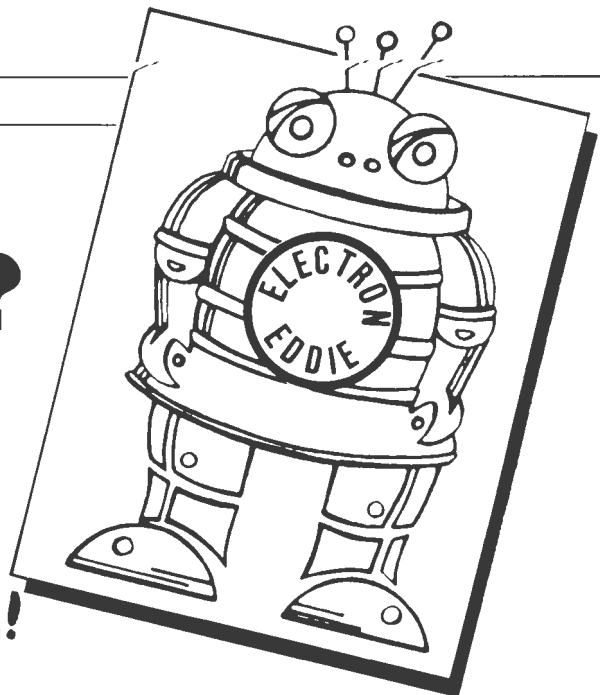

Stand No.	Name of Stand	No. of Eddies spotted
1	Acorn Computers Ltd	
2	Glengary Soft	
3	Golem	
4	Softspot	
5	Computer Agencies	
6	RH Electronic (Sales)	
7	LCL	
8	British Micro	
12	OIC Ltd	
13	Micro User Groups	
14	Oxford Microware	
15	MYB Software	
16	Micro Aid	
18	Microvitec	
21	Superior Software	
28	Viglen Computer Supplies	
34	Display Distribution	
36	MW Systems	
38	Microware	
44	CJE Microcomputers	
45	National Micro Centres	
49	Software Invasion	
51	Senator Software	
54	Economatics	
57	Bucon Ltd	
58	MGB Software	
59	Akhter Instruments	
64	Micro Power	
67	Watford Electronics	
70	Master Class Video Cassettes	

Stand No.	Name of Stand	No. of Eddies spotted
71	Opus Supplies Ltd	
72	Miniature Tool Company	
76	Oak Software	
77	Electronequip	
82	Oakleaf Computers	
83	C-Tech Computers	
84	Datel	
90	Micro User	
91	Advanced Memory Systems	
95	Educational Computing	
96	Kirklands Computer Centre	
97	Twillstar Computers	
101	CWP Computers	
105	Optima Software	
106	Micro Resources	
109	Pace	
112	GSL	
113	Lowland Designs	
116	SYSTEM	
120	Alligata Software	
121	Solidisk	
122	Clwyd Technics	
123	Clares Micro Supplies	
127	Computer Concepts	
132	Educational Software	
133	Cumana	
136	Commotion	
137	Micro User Technical Advice	
138	Logic Sales	
139	Kansas City Systems	

Name \_\_\_\_\_ Address \_\_\_\_\_

TOTAL NUMBER OF CARDS \_\_\_\_\_

Please hand your form into the Electron User Stand No. 39. Thanks.

# THE MICRO USER

# Be one of the first to get each issue!

A subscription will ensure you get your own personal copy **HOT OFF THE PRESSES** month after month for the next year.

Every owner of a BBC Micro – and everyone thinking of buying one – needs to get Micro User every month. It's the biggest, brightest, most authoritative yet completely independent guide to a machine that has so much potential you will never tire of reading about its remarkable capabilities.

You can buy Micro User from your local newsagent or station bookstall. Or you can take out a 12 months subscription and have it delivered by post.



Copies of these back issues are still available at £1.25 each

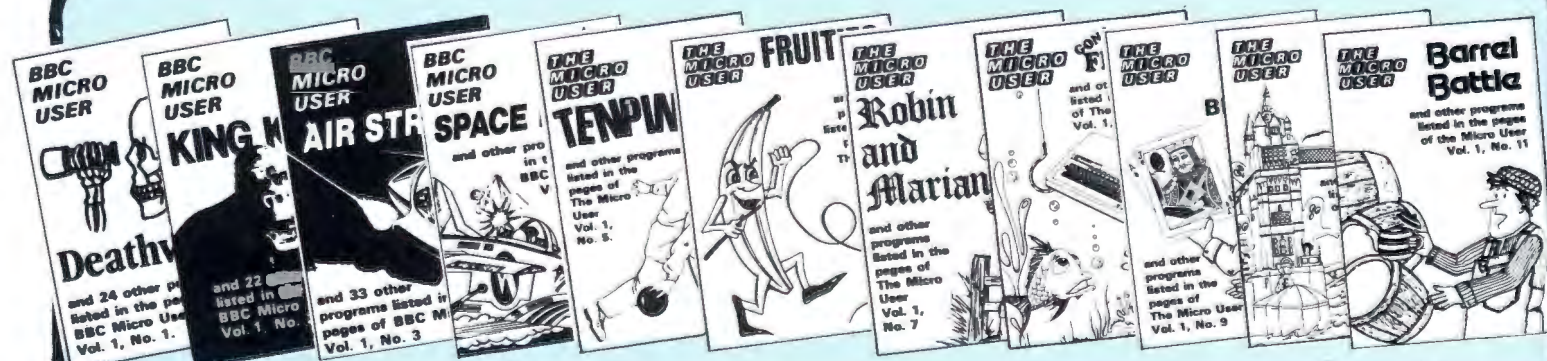

## Cassette tapes and discs of Micro User programs

Take out a year's subscription and have your cassette or disc posted to you each month. You can start your subscription from any issue to take advantage of this offer. Order on the coupon opposite.

TAPES  
£3.75  
each

DISCS  
£6.75  
each



**FREE**  
Cassette  
worth  
£3.75  
if you  
subscribe  
NOW!



If you take out a subscription to *Micro User* you will receive completely free one of the monthly cassettes of *Micro User* listings. Choose which one you want from those illustrated below. This free gift is for a limited period, so subscribe now!

Your BBC Micro  
needs protecting!

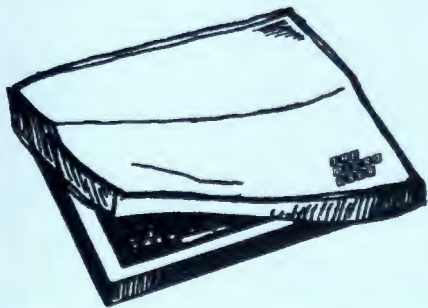

Deluxe  
(clear)

**£3.95**

Keep your collection of  
*Micro User* complete with  
these handsome binders

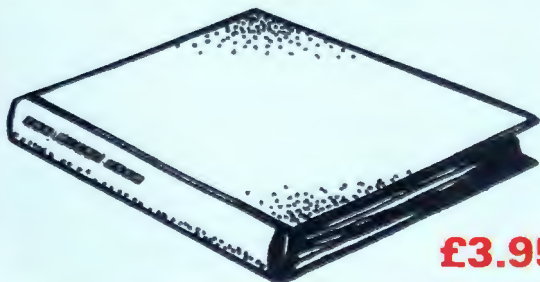

**£3.95**

(UK)

# ORDER FORM

All prices include postage, packing and VAT,  
and are valid to January 1, 1984.

Please enter number  
required in box

£ p

## Micro User

### annual subscription

UK £12   
EIRE £13 (IR £16)   
Surface mail - Rest of world £18   
Air mail - Rest of world £30

Selected free cassette ..... (month)

Commence with ..... issue TOTAL

### Micro User back issues

£1.25 UK  
Rest of world:  
 £1.50 - Surface  
 £2.50 - Air mail

March 1983   
April 1983   
May 1983   
June 1983   
July 1983   
Aug 1983   
Sept 1983   
Oct 1983   
Nov 1983   
Dec 1983

TOTAL

### Annual subscription:

£40 - Tape   
£70 - Disc

(UK & Overseas)

Commence with ..... (state month) TOTAL

### Cassette tape single copies

£3.75 - Tape  
£6.75 - Disc

(UK & Overseas)

Deathwatch Mar 1983   
King Kong April 1983   
Air Strike May 1983   
Space Pilot Jun 1983   
Tenpin Jul 1983   
Fruities Aug 1983   
Robin & Marian Sep 1983   
Gone Fishin' Oct 1983   
Blackjack / Goblins Nov 1983   
Tower Bridge Dec 1983   
Barrel Battle Jan 1984

TOTAL

### Dust Covers

£3.95 - Deluxe

(UK & Overseas)

TOTAL

### Binders

£3.95 - UK

£5.00 - Overseas

TOTAL

Payment: please indicate method (✓),

TOTAL

Access/Mastercharge/Eurocard  
 Barclaycard/Visa  
 American Express

Card No. \_\_\_\_\_

Expiry Date \_\_\_\_\_

Cheque/PO made payable to Database Publications Ltd.



Name \_\_\_\_\_

Address \_\_\_\_\_

Signed \_\_\_\_\_

Send to: **Micro User, FREEPOST, Europa House,  
68 Chester Road, Hazel Grove, Stockport SK7 5NY.**

(No stamp needed if posted in UK)

### You can also order by phone or Prestel

Any of the goods listed here can be ordered by telephone. Micronet subscribers and other users of Prestel can also use the Prestel Mailbox.

Telephone:  
**061-480 0171**  
9am - 5pm

Prestel Mailbox  
**614568383**  
24 hours

Don't forget to quote your credit card number.

# Make light work of these Body Building offers!

If you're not too hot with the soldering iron, *Micro User* is offering the light pen (October issue) and the sound to pattern converter (December issue) already fully assembled.

So all you have to do is fill in the coupon below, and we'll do the rest!



Assembled Sound to Pattern converter  
**£22.30**  
+ p&p

Assembled Light Pen  
**£18.35**  
+ p&p

## What the Beeb Body Building packs contain

Upgrade your BBC Micro with these Beeb Body Building Packs.

- Packs 1 and 2: Really use your User Port! These two packs let you safely and simply join your micro to the outside world. The best way to learn about interfacing.
- Pack 3: Give your BBC Micro real data-processing muscle by building yourself a dual cassette

system – the way Acorn said you couldn't.

- Packs 4 and 5: These packs allow you to control mains equipment in complete electrical isolation from your micro – the only safe way to do it. Pack 4 is rated at 4 amps, pack 5 at 10 amps.
- Pack 6: All the electronic components you'll need to

construct the Micro User light pen, with its special screen-sensing circuit.

- Pack 7: Two interesting experiments that should appeal both to schools and the amateur scientist: investigate the behaviour of a pendulum and study capacitor discharge.
- Pack 8: Construct this versatile sound to pattern converter. Its many applications include running

a light show with your BBC Micro. It will also make the micro a resident fixture in many music classes.

Also available are a fully-assembled light pen and sound-to-pattern converter. For a small extra charge constructors who run into difficulty assembling pack 8 can send it in for testing. It will be returned fully operational.

### YOUR ORDER FORM

for the Beeb Body Building packs

Please send me:	Described in issue	No.	Amount
Pack 1 @ £9.95	July 1983 page 83	<input type="checkbox"/>	£ .....
Pack 2 @ £9.95	July 1983 page 83	<input type="checkbox"/>	£ .....
Pack 3 @ £9.95	August 1983 page 85	<input type="checkbox"/>	£ .....
Pack 4 @ £9.95	Sept 1983 page 91	<input type="checkbox"/>	£ .....
Pack 5 @ £12.95	Sept 1983 page 91	<input type="checkbox"/>	£ .....
Pack 6 @ £13.65	October 1983 page 69	<input type="checkbox"/>	£ .....
Pack 7 @ £15.50	November 1983 page 71	<input type="checkbox"/>	£ .....
Pack 8 @ £16.55	December 1983 page 95	<input type="checkbox"/>	£ .....
Assembled light pen @ £18.35	October 1983 page 69	<input type="checkbox"/>	£ .....
Assembled sound to pattern converter @ £22.30		<input type="checkbox"/>	£ .....
Testing sound to pattern converter @ £9.70		<input type="checkbox"/>	£ .....
Plus post and packing			£1.00*
<b>Total</b>			<b>£ .....</b>

\*Postage and packing FREE if more than one pack is ordered

All prices include VAT

Name .....

Address .....

.....

.....

POST TO: BBC Packs, Micro User, Europa House, 68 Chester Road, Hazel Grove, Stockport SK7 5NY.

Please allow up to 28 days for delivery

# WALK-IN FORUM

You've read their articles in *Micro User* – now's your chance to hear our experts talking on their favourite subjects.

Machine code, interfacing, disc systems and education – we're going to cover them all.

And whatever you do, don't miss Experts Forum – the lively session that gives you a chance to quiz our team of writers.

## SATURDAY

**10.30 - 11.10** *Pete Davidson* – Micros in Education  
**11.15 - 11.55** *Ian Murray* – Machine code made simple  
**12.00 - 12.40** *Mike Cook* – Beeb Body Building  
**12.45 - 1.25** *Any Questions?* – an experts' forum

### Lunch

**2.15 - 2.55** *Jim Notman* – Discs on the BBC Micro  
**3.00 - 3.40** *Mike Cook* – Sound Connections (Music on your Beeb)  
**3.45 - 4.30** *Any Questions?* – an experts' forum

## SUNDAY

**10.30 - 11.10** *Ian Murray* – Machine Code Made Simple  
**11.15 - 11.55** *Mike Cook* – Beeb Body Building  
**12.00 - 12.40** *Any Questions?* – an experts' forum

### Lunch

**1.30 - 2.10** *Mike Cook* – Sound Connections (Music on your Beeb)  
**2.15 - 2.55** *Jim Notman* – Discs on your BBC Micro  
**3.00 - 3.40** *Any Questions?* – an experts' forum



## DO YOU WANT A WORD PROCESSOR FOR YOUR BBC OR A WORD PROCESSOR FOR YOUR BBC ?

Yes there is a difference between word processors and we can offer the best because it's the FIRST PROFESSIONAL DISC BASED WORD PROCESSOR FOR THE BBC COMPUTER.

The MERLIN SCRIBE uses the disc on your computer the same way that professional systems costing many hundreds of pounds do.

Until now any document you wished to create has been limited to the few pages which could be squeezed into your computer memory. This means the computer is really using the disc as if it were a cassette!

The SCRIBE can create documents far greater in size than the computer memory, and really uses the disc as it was intended to be used. SCRIBE automatically loads and offloads pages between disc and memory without you even knowing it's happening!

Amongst the many super features available are:

- \* Optional 40 & 80 column screen format selection.
- \* On screen formatting - you see it as it's printed INCLUDING UNDERLINING.
- \* Right justify, word wrap, insert, delete, move copy & centre.
- \* Document merge (will merge two documents into one from disc).
- \* Addresses all four drive units allowed by your BBC disc system.

SEE US ON  
STAND 57

Plus many more professional features.

SCRIBE comes in ROM with five minute fitting instructions, printer utilities on disc and a comprehensive manual.

PRICE £59.95

Also MERLIN SCRIBE in ROM for cassette machines £29.95, and on tape £19.95. All prices include VAT. Post and Packaging 60p.

VISA

MERLIN COMPUTER PRODUCTS (BUCON LIMITED)  
18 MANSEL STREET, SWANSEA, SA1 5SG. TEL (0792) 467980



**PROGRAMMERS**

**SYSTEM  
SOFTWARE**

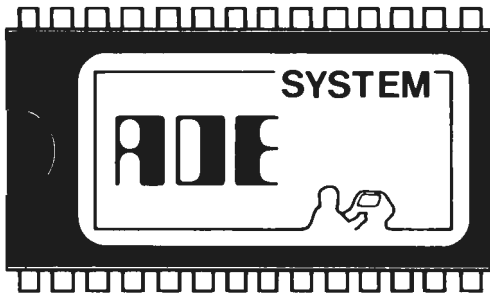

**IS HERE NOW!**

Come along to see and buy  
the most exciting new 16k  
utility ROM yet designed for  
the BBC Microcomputer.

A full MACRO ASSEMBLER... the  
most powerful EDITOR/Word  
Processor yet ... and the renowned  
SPY DEBUGGING MONITOR ...  
plus UTILITY DISC ... all for £60  
inc. VAT.

- OR** See SPY put through its paces
- OR** See and hear the celebrated MUSIC  
EDITOR in action.
- OR** Create character sets with CHARD  
look at ENVELOPES with our  
ENVELOPE GENERATOR.
- OR** View our excellent  
EDUCATIONAL  
SOFTWARE.

**SEE YOU AT  
STAND No.  
116**

**SYSTEM**

12 Collegiate Crescent, Sheffield S10 2BA. 0742 682321



# DISC SYSTEMS

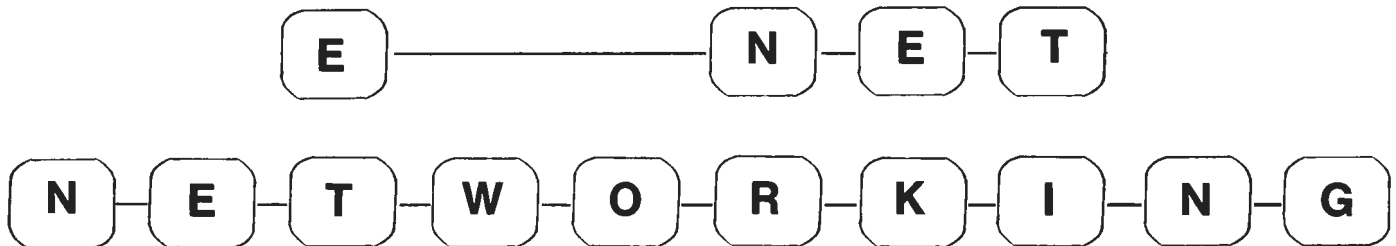

**VISIT US ON STAND NOS.  
109 - 111**

**SEE THE DEMONSTRATION OF THE E-NET,  
THE NEW AMCOM WINCHESTER BASED  
EDUCATIONAL NETWORKING SYSTEM FOR  
USE WITH THE BBC MICRO.**

See networked BBC's communicate with each other at different levels and note the following features:-

- Up to 252 BBC micros can be used.
- 10 meg up to 140 meg Winchesters are available.
- Each station can have its own printer if required or all stations can share a common printer. The printer server being available whilst printing is being executed.
- The file server has complete control over all client machines. All levels are designated a password and user number and these require to be entered (but are invisible on the VDU) before the user can enter the system.
- Different priority levels can be designated to individual users depending on status.
- Client machine users can be allocated variable amounts of space, each pupil not being restricted in this respect.
- Video only messages can be passed to a client machine offering advice or instruction. Alternatively programs can be loaded direct to the client machine by the file server.
- Each client's machine screen can be viewed by the teacher at any time.

Also available of course the full range of PACE 5¼" Floppy Disc Drives.

**PACE SOFTWARE SUPPLIES LTD.,  
92 New Cross Street, West Bowling, Bradford. BD5 8BS.  
Telephone: 0274 729306**

# Dodgy Dealer

"You'll be hard pressed to find a better business game for the BBC Micro than this grand effort" - (TV Choice Nov. 1983)



A captivating game emulating the real business world. As boss of a small manufacturing company, you are required to make executive decisions to enable your company to survive and even prosper in the face of strong competition.

The game is dynamic: the more your skills improve the greater the competition becomes. £6.50

★★★★★★★★★★★★★★★★

One of the biggest attributes that a computer has is the capability to sort vast amounts of information. But have you ever wondered how a computer carries out the sorting process?

## SORT ANIMATOR

is the first in the Computer Tutorial series by OIC, explaining visually and in detail how a selected variety of sorts work.

Also includes routines that can be used in your own programs. £6.50

★★★★★★★★★★★★★★★★

All products supplied on cassette for the BBC B 1.2 o/s. All prices include VAT & P+P

The complete OIC product range will consist of:

Text games	Early learning
Adventure games	Computer tutorial
Graphics games	Tools & utilities
Business applications	

Products available soon for the  
Electron CBM 64 VIC 20 Spectrum

## WATCH PRESS FOR ANNOUNCEMENTS

Products available from your local computer store or direct from:

**OIC Ltd., Dept. OPD/EX1, FREEPOST,  
Camberley, Surrey GU15 4BR.**

Dealers/Distributors

Contact Richard Edwards on (0344) 773229

# THE ROBIN

(copyright May 1983)

An amazing colour light pen that **PAINTS** on the BBC microcomputer.

*This pen was described by Infant and Junior teachers at the Nottingham Computer Show as "fantastic".*

## Choice of 7 colours:

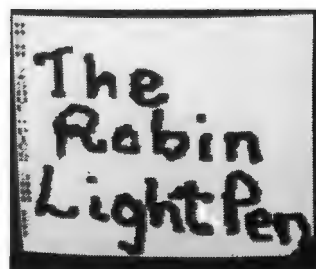

WRITES

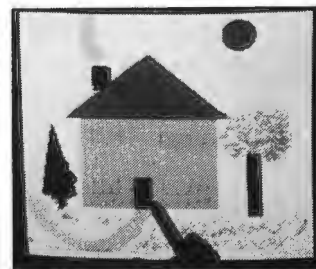

PAINTS



DRAWS



RUBS OUT

Plots coloured points, lines, triangles, rectangles and circles.

**SAVES and LOADS your pictures**

Pen and program . . . on cassette £25  
on disc £28

An entertaining Music Synthesiser program for the pen. Partial keyboard display, 4 octaves, 4 tempos and 14 functions: e.g. Piano, Drums, Bells etc.,  
On cassette at £6.50

Available from

**The Educational Software Co.  
(Southport)**

**41 Trafalgar Road, Southport PR8 2HF.**

Please send SAE for further information on newly developed programs and in particular for information on the Database quoted at £15,000 to develop and now in use by three County Councils.

# MRM SOFTWARE

## Britain's newest software house.

"It is our opinion that MRM's software is equal in stature to any currently on offer by leading manufacturers." Richard Tyner, Software Manager  
MICRONET 800

FOR THE BBC 32K

Previously only available on Micronet 800 – now by popular demand available direct to the public.

### Q-MAN



The very popular 3D pyramid game. Hop around the pyramid avoiding the bouncing balls and Jake the Snake. A highly entertaining game with increasing difficulty plus our own totally unique features. Game includes TRANSPORT DISCS, BONUS, HIGH-SCORE TABLE, HYPERSPACE and SMART BOMBS. Excellent graphics and terrific sound. One of the three top selling games on MICRONET this month.

### Q-MAN'S BROTHER



Q-MAN'S BROTHER is featured in the high score table of Q-MAN and now has his very own game. Have you time to paint all of the maze? Not if the PAINT POTS have anything to do with it or especially the deadly PAINT ROLLER which will erase all of your hard work! Increasing difficulty, excellent sound, AMAZING 3D graphics and high score.

### BANANA MAN



A totally new concept from MRM. You are the BANANA MAN and you must eat 40 BANANA SANDWICHES each minute to stay alive. There are BLUE BLOCKS which may prevent you from reaching the food and deadly PURPLE TARANTULAS that are fatal if stepped upon. ETHEL the CAT also appears but can be scared away for mystery points. But watch out, she conceals a spider. Features include BONUS BANANAS, BLOCK 'SHUFFLE', INCREASING DIFFICULTY, HIGH-SCORE TABLE and GREAT GRAPHICS.

### GUY IN THE HAT



You are THE GUY IN THE HAT entombed in a honeycomb labyrinth. Like BANANA MAN you have an increasing daily food diet, but this time your favourite snack is a BICKIE. Beware of the pursuing BICKIE BASHERS that are trying to ensnare you. Gain extra points by dropping your exploding hat and trapping the BICKIE BASHERS. Movement in 8 directions, HYPERLEAP and menacing sounds are included along with the usual great graphics and high-score table.

### SECRET SAM SERIES



Two great original adventure games from MRM. Written in plain English on a spy based theme. Travel around meeting AGENTS, collecting CLUES and ITEMS that will aid you in your mission. SAM1 and SAM2 are completely separate missions and each game is a thoroughly enjoyable adventure in its own right. Many hours of frustrating fun plus sound effects.

### 3D MUNCHY



A visually stunning version of the now legendary arcade classic ... with a difference. Eat power pellets whilst avoiding the GHOSTS as usual, but can you get past the HOLES? Absolutely amazing graphics and sounds, increasing difficulty and high score. All this and you're battling against the clock as well. A CLASSIC from MRM.

INTRODUCTORY OFFER

**EACH GAME ONLY £4.95 + 55p P&P PER ORDER**



**MRM SOFTWARE**  
17 Cross Coates Road  
GRIMSBY  
South Humberside  
Telephone: 0472 44304

DEALER  
DISCOUNTS  
AVAILABLE

# FLOPPY DISC SYSTEMS FOR THE BBC MICRO

**mws** announce a complete range of Disc Drives that are compatible with the BBC Micro and other micro-computers that utilise the Shugart SA400 Interface.

- **DISC DRIVE UNITS** come complete with high quality steel box, 40/80 Track Formatting Disc, Interface Cable and manual.
- All you need to do is plug into your BBC and you are ready to have access to large amounts of storage space.
- All single units can be upgraded to double units.
- All units carry a 1-year warranty.      • Optional power supply available. **£35**

**EXCITING NEW PRODUCT RELEASE** – See it at the London BBC Micro User Show



800K  
for only  
**£399**

**MWS Dual 400K Drives  
(Total 800K)**



400K  
for only  
**£233**

**MWS Single 400K Drive**



**MWS Single 400K Upgrade £220**

## **mw systems ltd.**

Matrix House  
Lincoln Road  
Cressex Industrial Est.  
High Wycombe  
Bucks  
Tel (0494) 450341

### ORDER FORM

Please send me the following items	Quantity	£
Dual 400K Drive Unit (800K) at £399		
Single 400K Drive Unit . . . . . at £233		
Single 400K Upgrade . . . . . at £220		
Power Supply . . . . . at £35		

Please debit my   Sub total \_\_\_\_\_  
 VAT at 15% \_\_\_\_\_  
 TOTAL \_\_\_\_\_

I enclose a cheque for £..... made payable to MW Systems Ltd

Name \_\_\_\_\_ Company \_\_\_\_\_

Address \_\_\_\_\_

Tel No \_\_\_\_\_

All prices are exclusive of VAT  
Available from Stock – Disc Interfaces P.O.A.